

Owner's Manual

ONE-PUMP (PU1) & TWO-PUMP (PU2) Version française au verso



OWNER'S INFORMATION

DEALER

Company _____
Address _____
Phone _____
E-mail _____

INSTALLER

Company _____
Address _____
Phone _____

SPA

Model (see below) _____
Serial Number (see below) _____
Color _____
Date of Delivery _____

For the model and serial numbers, locate the white plate to the right or left of the access panel, near the floor.

 Intertek 3126636	Roto Ops LLC Lake Mary, FL CONFORMS TO UL STD 1563						
	Model No:						
	Options:						
	Mfg Date:						
FOR INDOOR/OUTDOOR USE		<table border="1"><tr><td>Volts:</td></tr><tr><td>Amps:</td></tr><tr><td>CirBrk:</td></tr><tr><td>Hz:</td></tr><tr><td>SN:</td></tr></table>	Volts:	Amps:	CirBrk:	Hz:	SN:
Volts:							
Amps:							
CirBrk:							
Hz:							
SN:							
		Assembled In the USA					

TABLE OF CONTENTS

IMPORTANT SAFETY INSTRUCTIONS.....	4-9
SELECTING ELECTRICAL MODE AND A LOCATION.....	10-11
SPA COVER INSTALLATION.....	12
FILLING YOUR SPA.....	13
DRAINING YOUR SPA.....	14
FOR THE ELECTRICIAN, TWO-PUMP, PU2 MODELS.....	15-17
FOR THE ELECTRICIAN, ONE-PUMP, PU1, MODELS, CONVERT HEATER TO 240VOLT.....	18-20
SYSTEM OPERATION ONE-PUMP, PU1 MODELS.....	21-22
SYSTEM OPERATION TWO-PUMP, PU2 MODELS.....	23-24
DISPLAY MESSAGES.....	25
SKIMMER-FILTER, CLEANING OR REPLACEMENT OF THE FILTER CARTRIDGE.....	26
AIR INJECTOR VENTURI ADJUSTMENT.....	27
ADJUSTABLE WATER FLOW JETS.....	27
WATERFALL FLOW ADJUSTMENT.....	27
AROMA INFUSION.....	28
POP-UP FOUNTAINS.....	29
WATER CHEMISTRY.....	30-31
REPLACING THE LED LIGHT.....	32
HEADREST INSTALLATION.....	33
FREEZE PROTECTION.....	34
CLEANING YOUR SPA.....	34
CARE FOR THE WEATHERSHIELD COVER	34
FREQUENTLY ASKED QUESTIONS.....	35
PURGING THE PUMP.....	36
TROUBLESHOOTING GUIDE.....	37
GLOSSARY OF TERMS.....	38
OZONE (OPTIONAL EQUIPMENT)	39

Important Safety Instructions for all Spa Owners

READ AND FOLLOW ALL INSTRUCTIONS CAREFULLY!

This spa was manufactured to meet the standards and specifications outlined in the “Virginia Graeme Baker Pool and Spa Safety Act” (VGB Safety Act). When installing and using this spa, basic safety precautions should always be followed, including:



1. **DANGER: RISK OF INJURY: (For cord and plug connected units):**

- Replace damaged cord immediately
- Do not bury cord
- Connect to a grounded, grounding type receptacle only.

WARNING: (For units with a Ground Fault Circuit Interrupter (GFCI):

This product is provided with a Ground Fault Circuit Interrupter GFCI on the end of the spa’s power cord. This GFCI must be tested before each use. With the product operating depress the “test” button on the GFCI the spa should not operate. Depress the “reset” button on the GFCI. The product should now operate normally. If the spa fails to operate in this manner, there is a ground current flowing indicating a possible electric shock. Disconnect the power until the fault has been identified and corrected by a certified licensed electrician.

2. **WARNING: (For permanently installed units):**

The electrical supply for this product must include a suitably rated switch or circuit breaker to open all ungrounded supply conductors to comply with Section 442-20 of the National Electric Code. ANSI / NFPA 70-1987. In addition, all 230-volt installations must be protected by a 230-volt Ground Fault Circuit Interrupter GFCI. Any GFCI circuit breaker used in the house panel must read current returning through the neutral conductor. 230-volt 2 conductor GFCI circuit breakers will not operate correctly for your application.

3. **DANGER: RISK OF SEVERE INJURY OR DROWNING!**

- Extreme caution must be exercised to prevent unauthorized access by children.
- To avoid accidents, ensure that children do not use this spa unless supervised at all times. Adult supervision is a critical safety factor in preventing children from drowning.
- Use the straps and clip tie downs to secure the spa cover when not in use. This will help discourage unsupervised children from entering the spa. Keep the spa cover secure in high-wind conditions.
- There is no representation that the cover, clip tie-downs, or actual locks will prevent access to the spa.

4. **DANGER: RISK OF SEVERE INJURY OR DROWNING!**

- Keep hair, loose articles of clothing or hanging jewelry away from suction fittings, rotating jets or other moving components to avoid entrapment that could lead to drowning or severe injury.
- Never use the spa unless all suction guards, filter, filter lid, or skimmer assembly are installed to prevent body and/or hair entrapment.
- Never operate or use the spa if the filter, filter lid, or skimmer assembly are broken or any part of the skimmer assembly is missing. Please contact your dealer or nearest service center for service.
- The suction fittings and suction covers in this spa are sized to match the specific water flow created by the pump(s). If it is necessary to replace the suction fittings, suction covers or pump(s), be sure that the flow rates are compatible and are in compliance with the VGB Safety Act.
- Never replace a suction fitting or suction cover with one rated less than the flow rate marked on the original suction fitting. Using improper suction fittings or suction covers can create a body or hair suction entrapment hazard that may lead to drowning or severe injury.

5.  **DANGER: RISK OF SEVERE INJURY FROM ELECTRIC SHOCK OR DEATH FROM ELECTROCUTION!**

- Install the spa at least 5 feet (1.5m), from all metal surfaces. As an alternative, a spa may be installed within 5 feet of metal surfaces if each metal surface is permanently connected (bonded) by a minimum No. 8 AWG (8.4 mm²) solid copper conductor attached to the wire connector on the grounding bar, inside the equipment compartment on the equipment box.
- A grounding wire connector is provided on this unit to connect a minimum No. 8 AWG (8.4 mm²) solid copper conductor between this unit and any metal equipment, metal enclosures of electrical equipment, metal water pipe, or conduit within 5 feet (1.5m) of the unit.
- Never permit any electrical appliance, such as a light, telephone, radio, television, etc. within 5 feet (1.5m) of a spa unless such appliances are built-in by the manufacturer.
- Never bring any electrical appliances into or near the spa.
- Never operate any electrical appliances from inside the spa or when you are wet.
- Permanently installed units: The electrical supply for this product must include a suitably rated switch or circuit breaker to open all ungrounded supply conductors to comply with section 422-20 of the National Electrical Code/USA, ANSI/NFPA 70. The disconnecting means must be readily accessible and visible to the spa occupant but installed at least 5 feet (1.5m), from the spa.
- Permanently installed units: The electrical circuit supplied for the hot tub must include a suitable ground fault circuit interrupter (GFCI) as required by NEC Article 680-42.

6.  **WARNING: RISK OF SEVERE INJURY OR DEATH!**

- Extreme caution must be exercised to prevent diving or jumping into that the spa or slipping and falling, which could result in unconsciousness, drowning, or serious injury. Remember wet surfaces can be very slippery.
- Never stand, walk or sit on the top railing of the spa.
- Always use care in and around your spa. The spa has many rigid, unyielding parts and many areas that become wet and slippery; these are all potentially dangerous when rough play is permitted or if care is not used, particularly when entering or leaving the spa.



7.  **WARNING: RISK OF HYPERTHERMIA (OVER-HEATING) CAUSING SEVERE INJURY, BURNS, WELTS OR DEATH!**



- Water temperature in excess of 104°F (40°C) may be injurious to your health.
- Refer to Hyperthermia section on this manual for specific causes and symptoms of this condition.
- The water in the spa should never exceed 104°F (40°C). Water temperatures between 100°F (38°C) and 104°F (40°C) are considered safe for a healthy adult.
- Lower water temperatures are recommended for young children (children are especially sensitive to hot water) and when spa use may exceed 10 minutes.
- The Consumer Products Safety Commission/USA has stated that the water temperature in a spa should not exceed 104°F (40°C).
- Always test the spa water temperature before entering the spa. The user should measure the water temperature with an accurate thermometer since the tolerance of water temperature regulating devices may vary as +/- 5°F (2°C).

8.  **WARNING: RISK OF SEVERE INJURY OR DEATH!**

- Since excessive water temperatures have a high potential for causing fetal damage during the early months of pregnancy, if pregnant or possibly pregnant, consult your physician before using a spa.
- Pregnant or possibly pregnant women should limit spa water temperatures to 100°F (38°C).
- Persons suffering from obesity or a medical history of heart disease, low or high blood pressure, circulatory system problems, diabetes, infectious diseases or immune deficiency syndromes should consult a physician before using a spa.
- If you experience breathing difficulties in association with using or operating your spa, discontinue use and consult your physician.
- Persons using medication should consult a physician before using a spa since some medication may induce drowsiness, while other medication may affect heart rate, blood pressure, and circulation.
- Persons suffering from any condition requiring medical treatment, the elderly, or infants should consult with a physician before using a spa.
- If you have any questions about your own fitness or whether you should soak in the spa, check with your physician.
- The use of alcohol, drugs, or medication before or during spa use may lead to unconsciousness with the possibility of drowning.
- Never permit the spa to be used unless it is attended by at least one person other than the bather. Someone should be present to lend assistance if the bather should be in trouble due to injuries, cramps, or drowning, especially in case of children.

9.  **WARNING: RISK OF SEVERE INJURY OR DEATH!**

- Prolonged immersion in a spa may be injurious to your health.
- Observe a reasonable time limit when using the spa. Exposures at higher temperatures can cause high body temperature (over-heating). Symptoms may include dizziness, nausea, fainting, drowsiness, and reduced awareness. These effects could possibly result in drowning or serious injury.
- Never use a spa immediately following strenuous exercise. Enter and exit the spa slowly. Wet surfaces can be slippery.

10.  **WARNING: TO DECREASE RISK OF INFECTION OR DISEASE!**
- To reduce the risk of contracting a waterborne illness (e.g., an infection, bacteria or virus) and/or respiratory ailments, maintain water chemistry within the parameters listed in the Water Chemistry section of this manual and consult with a licensed engineer regarding proper ventilation if installed indoors or in an enclosed area.
 - People with infectious diseases should not use a spa to avoid water contamination, which could result in spreading infections to others.
 - Always shower before and after using your spa. Maintain water chemistry in accordance with manufacturer's instructions. Failure to do so may result in contracting a waterborne illness (e.g., an infection, bacteria or virus).
11.  **WARNING:** In addition to maintenance of filters and water chemistry, proper ventilation is recommended to reduce the risk of contracting a waterborne illness (e.g., an infection, bacteria or virus) and/or respiratory ailments that could be present in the air or water. Consult a licensed architect or building contractor to determine your specific needs if installing your hot tub indoors.
12. **CAUTION: TO DECREASE RISK OF PRODUCT DAMAGE.**
- Maintain water chemistry in accordance with manufacturer's instructions.
 - Proper chemical maintenance of spa water is necessary to maintain safe water and prevent possible damage to spa components.
13.  **WARNING: RISK OF SEVERE INJURY OR DEATH!** The appliance is not intended for use by persons (including children) with reduced physical, sensory or mental capabilities, or lack of experience or knowledge, unless they have been given supervision or instruction concerning use of the appliance by a person responsible for their safety.
14. **NOTE:** This spa is not intended nor designed to be used in a commercial or public application. The spa buyer shall determine whether there are any code restrictions on the use or installation of this spa since local code requirements vary from one locality to another.

Hot Tub Safety Literature

To ensure you have a safe and enjoyable hot tub experience, learn all you can about hot tub safety and emergency procedures.

The Pool & Hot Tub Association has a great source of safety literature.

Go to <http://phta.org>

Conduct your own search on the internet.

Write to the following address:

Pool & Hot Tub Association

2111 Eisenhower Avenue

Alexandria VA 22314

703.838.0083

FOR CALIFORNIA RESIDENTS ONLY NUR FÜR EINWOHNER KALIFORNIENS
POUR LES RÉSIDENTS DE LA CALIFORNIE SEULEMENT PARA RESIDENTES DE CALIFORNIA ÚNICAMENTE



WARNING: Drilling, sawing, sanding or machining wood products can expose you to wood dust, a substance known to the State of California to cause cancer. Avoid inhaling wood dust or use a dust mask or other safeguards for personal protection. For more information go to www.p65Warnings.ca.gov/wood



ACHTUNG: Das Bohren, Sägen, Schleifen oder Zerspanen von Holzprodukten kann Stäube freisetzen. Diese Substanz gilt im US-Bundesstaat Kalifornien als krebserregend. Möglichst keinen Holzstaub einatmen bzw. eine Staubmaske oder anderweitige persönliche Schutzmaßnahmen einsetzen. Weitere Informationen finden Sie auf www.P65Warnings.ca.gov/wood



AVERTISSEMENT: Le forage, le sciage, le ponçage ou l'usinage des produits du bois peuvent vous exposer à la poussière de bois, une substance connue dans l'État de Californie pour causer le cancer. Éviter d'inhaler la poussière de bois ou utiliser un masque antipoussières ou d'autres mesures de protection personnelle. Pour de plus amples renseignements, consulter le site www.P65Warnings.ca.gov/wood



ADVERTENCIA: Perforar, cortar, lijar o usar máquinas con productos de madera le puede exponer a polvo de madera, una substancia reconocida por el Estado de California como causante de cáncer. Evite inhalar polvo de madera o utilice una máscara antipolvo u otros resguardos para protección personal. Para más información, visite www.P65Warnings.ca.gov/wood

6530-460 Rev A (12/18)

FOR CALIFORNIA RESIDENTS ONLY NUR
FÜR EINWOHNER KALIFORNIENS
POUR LES RÉSIDENTS DE LA CALIFORNIE SEULEMENT
PARA RESIDENTES DE CALIFORNIA ÚNICAMENTE



WARNING: Cancer and Reproductive Harm
www.p65Warnings.ca.gov



ACHTUNG: Krebserregend und mit fortpflanzungsschädigender
Wirkung-www.p65Warnings.ca.gov



AVERTISSEMENT: Cancer et danger pour la reproduction
www.p65Warnings.ca.gov



ADVERTENCIA: Cáncer y daño reproductivo
www.p65Warnings.ca.gov

6530-464 Rev A (12/18)

Entrapment Risk

The Consumer Products Safety Commission/USA has reported that users of pools and spas have become entrapped (stuck) to drain and/or suction fittings causing death, drowning, or serious injury (see diagram below). This spa was manufactured to meet the standards and specifications outlined in the "Virginia Graeme Baker Pool and Spa Safety Act" (VGB Safety Act). Entrapment risk can be minimized if proper precautions are taken.

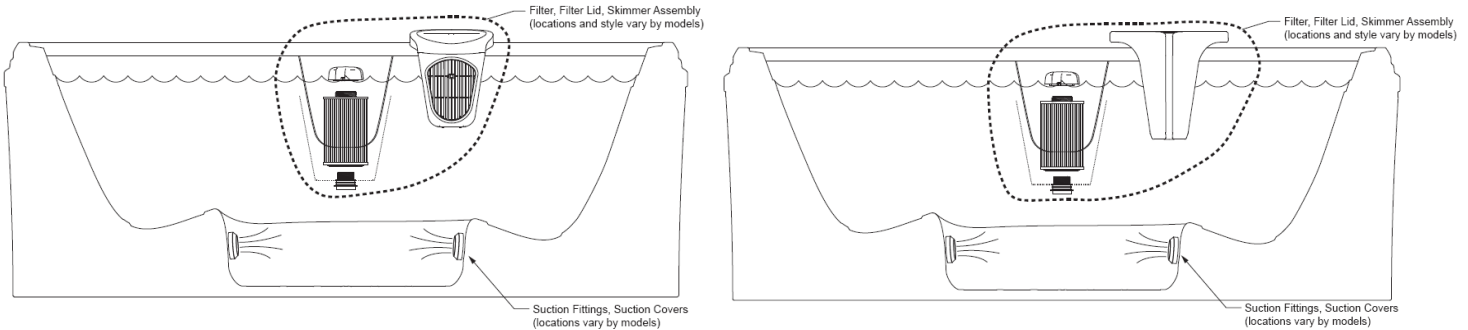
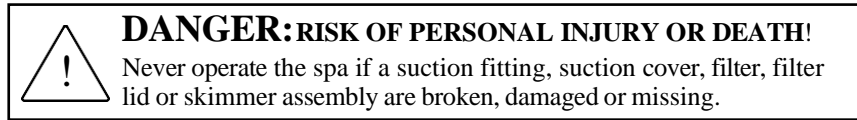

Note: Suction covers must be replaced every 7 years.

1. **⚠ DANGER: RISK OF SEVERE INJURY OR DROWNING! Hair entrapment:** May occur if hair is entangled, knotted or snagged in a drain suction or skimmer assembly. This has been reported in persons who when submerge themselves underwater, allowing hair to come close and/or within the reach of the suction fittings, suction covers or skimmer assembly.

 - Keep hair away from suction fittings, suction covers, filter, filter lid or skimmer assembly.
 - Children are at risk for hair entrapment if swimming under water.
 - Never allow children to play or get near the suction fittings, suction covers, filter, filter lid or skimmer assembly.
2. **⚠ DANGER: RISK OF SEVERE INJURY OR DROWNING! Limb entrapment:** May occur when a limb becomes entrapped, inserted or sucked into a suction or outlet opening.

 - Always keep suction fittings, suction covers, filter, filter lid or skimmer assembly in place when operating to avoid limb entrapment.
 - Never allow children to play or get near the suction fittings, suction covers, filter, filter lid or skimmer assembly.
3. **⚠ DANGER: RISK OF SEVERE INJURY OR DROWNING! Body entrapment:** May occur when part of the torso becomes entrapped, inserted or sucked into a suction or outlet opening.

 - Never allow children to play or get near the suction fittings, suction covers, filter, filter lid or skimmer assembly.
4. **⚠ DANGER: RISK OF SEVERE INJURY OR DROWNING! Evisceration (disembowelment) entrapment:** May occur when the buttocks become entrapped, inserted or sucked into a suction or outlet opening.

 - Never sit on suction fittings, suction covers, filter, filter lid or skimmer assembly.
 - Never allow children to play or get near the suction fittings, suction covers, filter, filter lid or skimmer assembly.
5. **⚠ DANGER: RISK OF SEVERE INJURY OR DROWNING! Mechanical entrapment:** May occur when jewelry, swimsuit, or hair accessories become entangled, knotted or snagged in a drain suction or skimmer assembly.

 - Never allow your jewelry, swimsuit, or hair accessories to come close to the suction fittings, suction covers or skimmer assembly.
 - Never allow children to play or get near the suction fittings, suction covers, filter, filter lid or skimmer assembly.

Hyperthermia

Prolonged immersion in hot water may induce hyperthermia (overheating). The use of alcohol or drugs can greatly increase the risk of fatal hyperthermia in spas. A description of the causes, symptoms, and effects of hyperthermia are as follows:

Hyperthermia occurs when the internal temperature of the body reaches a level several degrees above the normal body temperature of 98.6°F (37°C). The symptoms of hyperthermia include drowsiness, lethargy (fatigue), and an increase in the internal temperature of the body (feeling of being too hot). The effects of hyperthermia include:

- Unawareness of impending hazard.
- Failure to perceive heat.
- Failure to recognize the need to exit spa.
- Physical inability to exit spa.
- Fetal damage in pregnant women; and
- Unconsciousness and DANGER of drowning.

Important Additional Safety Instructions

When using this electrical equipment, basic safety precautions should always be followed, including the following:

- 1. READ AND FOLLOW ALL INSTRUCTIONS.**
2. Permanently installed units: A green colored terminal or a terminal marked G, Gr, Ground, Grounding or the  symbol* is located inside the supply terminal box or compartment. To reduce the risk of electric shock, this terminal must be connected to the grounding means provided in the electric supply service panel with a continuous copper wire equivalent in size to the circuit conductors that supply this equipment (*IEC Publication 417, Symbol 5019).
3. A grounding bar is provided on the outside of the equipment box. To reduce the risk of electric shock, connect the local common bonding grid in the area of the spa to this grounding bar with an insulated or bare copper conductor not smaller than No. 6 AWG (10 mm²).
4. All field installed metal components such as rails, ladders, drains or other similar hardware within 10 feet (3m) of the spa shall be bonded to the equipment grounding buss with copper conductors not smaller than No. 6 AWG (10 mm²).
- 5. SAVE THESE INSTRUCTIONS.**

Selecting electrical mode

WARNING! DO NOT STORE SPAS OUTDOORS WITHOUT PROPER WATER LEVEL.

A spa stored outside in direct sun, without proper water level, uncovered or under a tarp/cover, can accumulate temperatures that will damage the spa, its components and void the warranty. Only store an empty spa indoors or in the shade.

One-pump (PU1) models

Will you operate the spa on 120- or 240-volts heater?

Your spa comes ready to plug into a standard 120 volt / 15-amp outlet for power. However, the heater can be converted from 120-volt 1000 watts to 240 volt 4000 watts, with a hard-wired power supply installed by a licensed certified electrician. Please read the following to help with your decision.

120 volts: When connected with the 120-volt plug, the heater is 1000 watts and operates only in the low-speed filtration mode. When the jet pump operates, the heater will turn off. This means the water will begin to cool while using the jet pump and the heat recovery time will take longer than it will if wired 240 volts. Many find this adequate due to their mild climate or shorter length of usage. Additionally, many prefer not to hire an electrician for the installation.

240 volts: When hard-wired to a 240-volt power supply, the heater is 4000 watts. It can operate on a 30- or 40-amp service.

On a 30-amp service the heater will not operate with the jet pump. However, the higher heater wattage will greatly increase the heat recovery time. The 30-amp circuit is often selected when there is limited available power as seen in some older homes.

On a 40-amp service the heater will operate with both high and low speed. This means the spa will heat while you operate the jet pump.

If you have decided to operate your spa on 120 volts, will your electrical cord reach an outlet?

Locate your spa so that the GFCI plug, and cord will reach a standard 120 volt / 15-amp outlet*, but not closer than 5 feet (1.5m). Do not use an extension cord. Use of an extension cord will void your warranty. To extend the power cord, with a Philips screwdriver remove the access panel, locate the coiled GFCI cord, uncoil and extend the cord. Ensure that the cord is routed through the notch at the lower center of the opening before reinstalling the access panel. Do not connect to the outlet until the spa is filled with water (see page 13).

If you have decided to convert your spa to 240 volts, a certified licensed electrician is required for the electrical installation. In this case, you may want to consult with your electrician before final positioning of your spa. Have your electrician see pages 18-20 for conversion instructions.

*To avoid nuisance circuit breaker tripping, it is best to use an outlet on a circuit which does not supply power to any other major running appliance. This can be checked by turning off the circuit breaker that supplies the intended outlet and verifying that no other electrical devices no longer work, such as a refrigerator, dishwasher, washing machine, coffee maker, hair dryer, etc.

Two-pump (PU2) models:

Electrical power supply: a certified licensed electrician is required for the electrical installation. You may want to consult with your electrician before final positioning of your spa. Have your electrician see pages 15-17 for more information.

Choosing A Location

IMPORTANT: Because of the combined weight of the spa, water and users, it is extremely important that the base upon which the spa rests be smooth, flat, level and capable of uniformly supporting this weight, without shifting or settling, for the entire time the spa is in place. If the spa is placed on a surface which does not meet these requirements, damage to the skirt and/or the spa shell may result. Damage caused by improper support is not covered under warranty. It is the responsibility of the spa owner to assure the integrity of the support over time. We recommend a poured, reinforced concrete slab with a minimum thickness of 4 inches (10 cm). Wood decking is also acceptable provided it is constructed so that it meets the requirements outlined above.



WARNING: For spas that are to rest on balconies, roofs or other platforms not specifically tied into main structural support consult a professional Structural Engineer with experience in this type of application.



WARNING: Proper drainage is required. The installation must not allow the spa equipment bay to become flooded or wetted (by external water). It is your responsibility, and the responsibility of any installation contractor you hire, to make sure that all applicable codes and/or local construction requirements are met. If in doubt, refer to the building authority responsible for approving the proposed installation site.

The spa must be installed in such a manner as to provide drainage away from it. Placing the spa in a depression without provisions for proper drainage could allow rain, overflow, leaks from spa plumbing, and other casual water to flood the equipment and create a wet condition in which it would sit in. For spas which will be installed below grade or recessed into a floor or deck, install to permit access to the equipment, either from above or below, for servicing. Make certain that there are no obstructions which would prevent removal of all cabinet side panels and access to the jet components, especially on the side with the equipment bay.

 **CAUTION:** If the spa is indoors or located in an enclosed area, proper ventilation should be discussed with an Engineer or authority competent enough to understand the necessary provisions needed to vent moist or heated air and air associated with chemical odors outdoors. When the spa is in use considerable amounts of moisture will escape potentially causing mold and mildew. This can cause health risk. Over time, this can damage certain surfaces, surroundings, and equipment.

Outdoor Location

In selecting the ideal outdoor location for your spa, we suggest that you take into consideration:

- The proximity to changing area and shelter (especially in colder weather).
- The pathway to and from your spa (this should be free of debris so that dirt and leaves are not easily tracked into the spa).
- The closeness to trees and shrubbery (remember that leaves and birds could create extra work in keeping the spa clean).
- Asheltered environment (less wind and weather exposure can result in lowered operation and maintenance costs).
- The overall enhancement of your environment. It is preferable not to place the spa under an unguttered roof overhang since run-off water will shorten the life expectancy of the spa cover.
- For spas that are to rest on balconies, roofs or other platforms not specifically tied into main structural support, consult a professional Structural Engineer with experience in this type of application.
- In the unlikely event that you should ever need to access or gain entry to any portion of the spa for servicing, it is highly recommended that you plan your outdoor installation to provide full access to the entire spa. Please take this into consideration when placing the spa in a deck or enclosed by a surrounding.
- Consider locating your spa away from any reflective surface or glass to prevent any damage to the spa and cabinet.
- Do not shim the spa. To ensure proper support the spa must sit flat on the intended foundation.

Indoor Location

For indoor installations many factors need to be considered before installing a spa indoors:



WARNING: In addition to maintenance of filters and water chemistry, proper ventilation is recommended to reduce the risk of contracting a waterborne illness (e.g., an infection, bacteria or virus) and/or respiratory ailments that could be present in the air or water. Consult a licensed architect or building contractor to determine your specific needs if installing your hot tub indoors.

- **Proper Foundation:** Consult a Structural Engineer when considering a foundation that will adequately support the spa the entire time it is in place. Proper support is critical especially if the spa is to rest on a second story or higher. For spas that are to rest on balconies, roofs or other platforms not specifically tied into the main structural support, you should consult a professional Structural Engineer with experience in this type of application.
- **Proper Drainage:** It is extremely important to have in place measures to sufficiently handle excessive water spillage. Be sure the flooring in which the spa rests on have adequate drainage and can handle the entire contents of the spa. Be sure to make provisions for ceilings and other structures that may be below the spa's installation. Areas around your spa can become wet or moist so all flooring and subsequent furniture, walls and adjacent structures should be able to withstand or resist water and moisture.
- **Proper Ventilation:** Proper ventilation should be discussed with an Engineer or authority competent enough to understand the necessary provisions needed to vent moist or heated air and air associated with chemical odors outdoors. When the spa is in use considerable amounts of moisture will escape, potentially causing mold and mildew over time which can damage certain surfaces and/ or surroundings.
- **Sufficient Access:** In the unlikely event that you should ever need to access or gain entry to any portion of the spa for servicing, it is highly recommended that you plan your indoor installation to provide full access to the entire spa.
- **Warranty:** Damage caused by not following these guidelines or any improper installation not in accordance to local codes or authorities is not covered under the spas warranty. Please consult your local state or city building ordinances.
- **Do not shim the spa.** To ensure proper support the spa must sit flat on the intended foundation.

Spa Cover Installation



WARNING: AVOID DROWNING RISK

- Failure to follow instructions may result in injury or drowning.
- Non-secured covers are a hazard.
- Keep children away. People or objects cannot be seen under the cover.
- Because of entrapment possibility, remove cover completely before entry of bathers.
- Excess weight can break the insulating foam, bend the steel reinforcement and damage the cover. Do not allow people or pets to stand or sit on the cover. Do not allow loads such as snow, leaves or anything else to accumulate on the cover. Do not use the cover as a table.

Caution, to avoid damage to the cover always remove the cover while adding chemicals to the spa water. This will prevent damaging chemical vapors from being trapped under the spa cover. These vapors can prematurely damage the cover material and void the warranty.

When properly installed, the cover supplied with your spa meets the Manual Safety Cover requirements of ASTM F1346-91.

If you are installing your spa near a wall or with any type of structure on the outside, such as a gazebo, remember to allow access for cover removal.

To deter entrapment by somebody slipping under the cover, ensure that all latches supplied with the cover are securely screwed to the cabinet, straps are inserted into the latches, the latches are locked, and the key is kept in a secure location.

Keep the spa covered when not in use to deter entry by unauthorized persons, reduce the loss of heat, and keep out rain and to keep foreign materials from settling in the water.

Follow these steps to properly install the cover.

1. Place the spa cover on top of the spa. Ensure the cover flaps and straps are not under the cover. Ensure the cover is properly seated in its final position.
2. Each strap is supplied with a cabinet latch snapped in place. Leave the cabinet latches at the end of the straps but remove the bag containing the screws and while lightly pulling downward on a strap, mark the center bottom of the latch (Fig 1). A piece of tape may be a good method to do this. Mark each remaining strap in the same way.
3. Remove the strap by pinching the two barbs of the strap as indicated (Fig 2).
4. Hold the cabinet latch on the mark and using a Phillips screwdriver, drive three screws through the holes in the cabinet latch and into the outside of the spa (Fig 3).
5. While the spa is not in use place the cover on top of the spa and snap all straps into the cabinet latches. To further protect against entry, lock each latch by quarter turning the key clockwise (Fig 4). Store the key in a secure place.

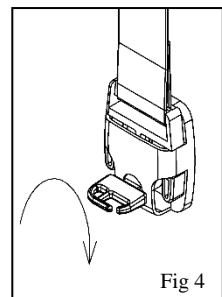
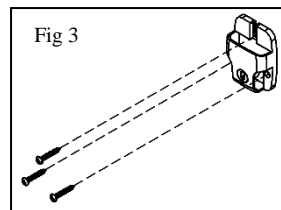
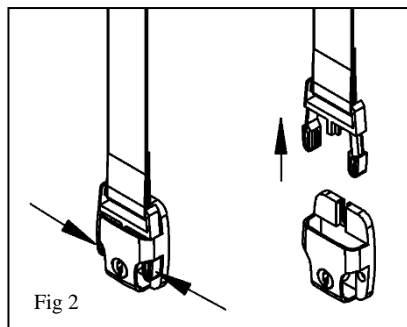
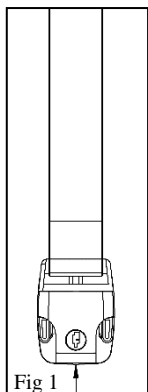

Filling Your Spa

WARNING: RISK OF PERSONAL INJURY!

- To decrease the risk of injury, drowning or entrapment, never leave your hot tub unattended for any reason while the cover is open and accessible, especially to small children and animals!
- Precautions should be taken to minimize your exposure to chemical vapors (that could cause lung, brain, or skin damage).

CAUTION: TO DECREASE BUILD UP ON COMPONENTS AND MINIMIZE SURFACE DAMAGE.

Never fill with water from a water softener. If your water is extremely “hard,” it is preferable to fill half-way with hard water and the rest of the way with softened water. Water that is too soft can be corrosive to metal components.

CAUTION: Your spa is constructed of a very resilient and flexible polymeric material. It is designed to flex as much as 2 inches (5cm) without damage. However, overfilling the spa and/or installing on a non-level surface for extended periods of time can permanently distort the original shape of your spa, cause structural damage, effect the sealing of the cover and void your warranty.

TO FILL THE SPA

Remove the access panel and ensure the drain valve is closed and the cap is secure (Fig 5).

Place a garden hose into filter area (Fig 7) and fill the spa with cold (never warm or hot) water 6 to 8 inches (15 to 20 cm) below the top edge of the spa (Fig 6). If there is not enough water in your spa, the pump may suck air into the plumbing system thereby damaging the pump or heater and void the warranty. Do not overfill, as the spa’s water level will rise as each person enters the spa. Always keep the spa water level above the jet openings.

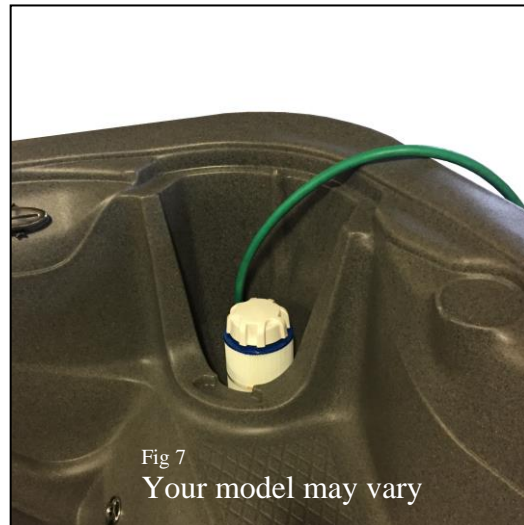
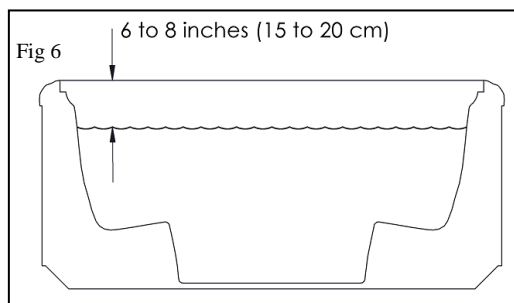
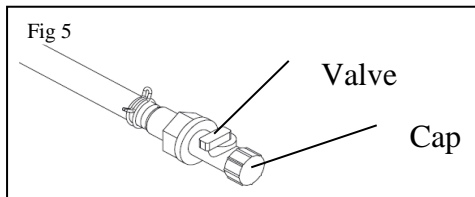

Draining the spa

WARNING: RISK OF PERSONAL INJURY!

- To decrease the risk of injury, drowning or entrapment, never leave your hot tub unattended for any reason while the cover is open and accessible, especially to small children and animals!
- Precautions should be taken to minimize your exposure to chemical vapors (that could cause lung, brain, or skin damage).

Draining your spa on a regular basis rids the spa of dissolved solids and protects your spa equipment from the effects of residual calcium hardness and total alkalinity problems. Depending upon usage, it may be as often as every three months.

To drain the spa, follow these steps:

1. Turn power off to the spa.
2. Remove the access panel and locate the drain valve (Fig 5).
3. Ensure that the drain valve is in the off position (as shown in Fig 5). Remove the cap (Fig 5) and attach a standard garden hose to the drain valve (Fig 8).

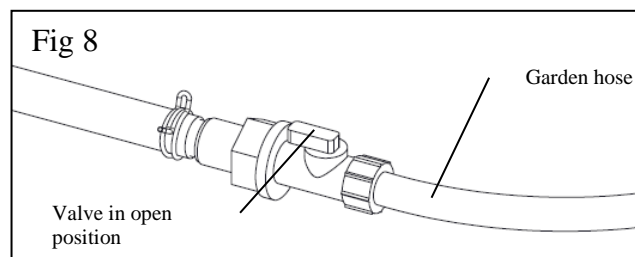

4. Route the garden hose to a sewer drain capable of safely assimilating 300 plus gallons (1135 liters) of water which may contain both unsanitary contaminants and chemical residue. Open the drain valve (as shown in Fig 8). The spa drains slowly.
5. The spa can only drain to the lowest jet. It may be necessary to manually remove the remaining water.
6. Before refilling your spa, ensure that the drain valve is in the off position and the cap is secured (Fig 5).

Two-pump (PU2) models, FOR THE ELECTRICIAN

Installations that do not adhere to these instructions can expose users to electric shock and will void the warranty.

Power Requirements

240VAC, 60HZ, 50A, Class A GFCI-protected service (Circuit Breaker rating 50A).

4 wires (hot, hot, Neutral, ground).

GFCI PROTECTION: The new service must be protected with by a GFCI and a disconnect switch. The National Electrical Code requires that spas connected to 240 volts circuits be equipped with a GFCI and disconnect switch. See National Electric Code Articles 680-12 and 680-42. This spa is not equipped with a 240-volt GFCI or a disconnect switch. A GFCI must be installed by a certified licensed electrician.

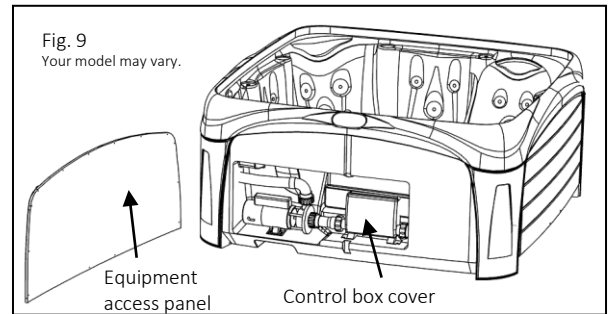

OUTDOOR LOAD CENTER: The addition of an outdoor load center such as a Siemens W0408ML 1125 or equal must be added to the circuit. This type of load center provides both a GFCI and Disconnect Switch in a convenient configuration as required by the National Electric Code. (See next page for suggested wiring configuration)

ISOLATED, DEDICATED 240 VOLT, 50 AMP CIRCUIT IS REQUIRED An isolated, dedicated 240-volt 50-amp circuit is required to provide the power necessary to properly operate the 240V equipment package.

PERMANENTLY HARD WIRED: All 240-volt operations wiring must be permanently hard wired, installed in grounded conduit and installed in compliance with the National Electrical Code and all local codes. Do not use an extension cord. Use of an extension cord will void the warranty.

WIRE SIZING MUST MEET ELECTRICAL CODES: All installations are different. Wire sizing must meet the National Electrical Code and all local code specifications.

To make electrical connections, remove the access panel as shown in Fig 9. Locate the control box, remove the cover and make connections.

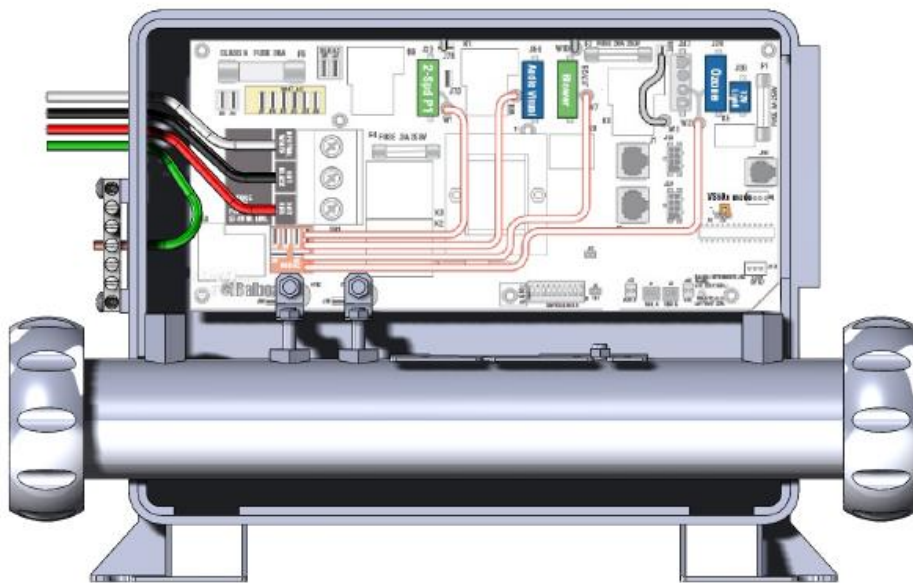

See next two pages for more electrical details

**Two-pump (PU2) models, FOR THE ELECTRICIAN continued
ELECTRICAL DATA FOR THE USE OF CERTIFIED LICENSED ELECTRICIAN
REQUIRED WIRING FOR 240 VOLT 4 WIRE INSTALLATION**

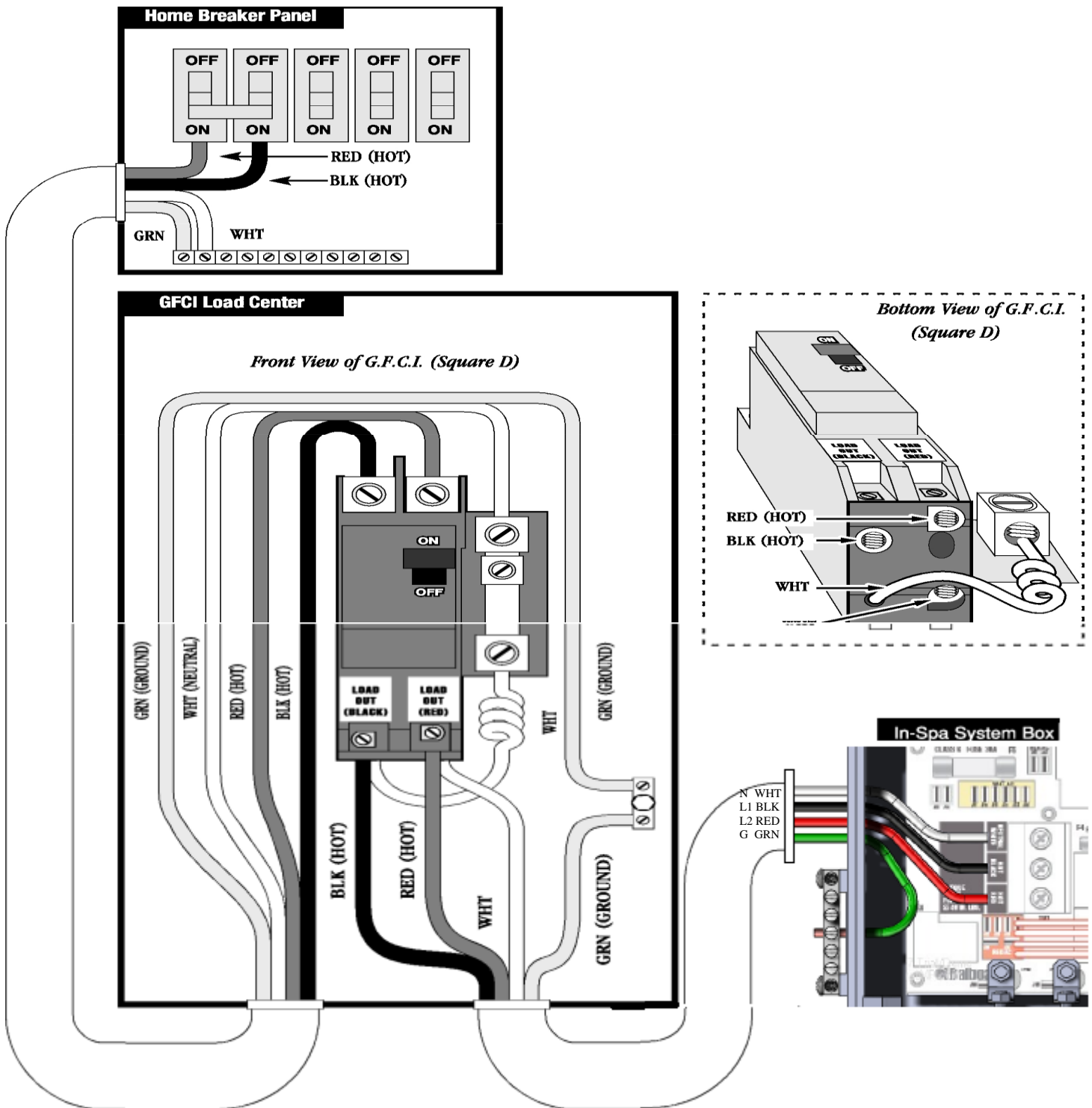

WARNING: Shock Hazard! Under No Circumstances Should This Spa Be Installed by Anyone Other Than A Certified Licensed Electrician!

Two-pump (PU2) models, FOR THE ELECTRICIAN continued

DIP SETTINGS VS501Z, 54379-03, Setup 2

MAIN POWER TO SYSTEM MUST BE TURNED OFF BEFORE ADJUSTING DIP SWITCHES

<p>DIP SETTINGS</p> 	TEST MODE OFF	← 1	TEST MODE ON
	STD, ECON, SLEEP ALLOWED	2 →	STANDARD MODE ONLY
	DUPLEX PANEL	3 →	MINI PANEL
	N/A MUST BE OFF	← 4	N/A MUST BE OFF
	N/A MUST BE OFF	← 5	N/A MUST BE OFF
	60HZ OPERATION	← 6	50HZ OPERATION
	TWO PUMPS	← 7	ONE PUMP
	DEGREES FAHRENHEIT	← 8	DEGREES CELSIUS
	N/A MUST BE OFF	← 9	N/A MUST BE OFF
	HIGH AMP – HEAT W/P1 HI	← 10	LOW AMP – NO HEAT W/P1 HI

FOR THE ELECTRICIAN, CONVERSION FROM 120V TO 240V, One-pump (PU1) models

Installations that do not adhere to these instructions can expose users to electric shock and will void the warranty.

The conversion of the equipment package, from a factory installed 120-volt system to a hardwired 120/240-volt system, must be completed by a certified licensed electrician. This procedure will convert the heater from 120 volts (1000 watts) to 240 volts (4000 watts). All other electrical components will remain 120 volts, so it will be necessary to include a neutral wire in the new electrical service. It will also be necessary to select how the heater will operate, thereby dictating the size of the new electrical service. If the heater will operate only when the low-speed pump is running, then a 30-amp service will be used, and the #10 dip switch will be set to the **low amp** position (page 20). If the heater will operate when both high and low-speed pumps are running, then a 40-amp service is required, and the #10 dip switch will be set in the **high amp** position (page 20). Regardless of your choice, the following will also have to be done.

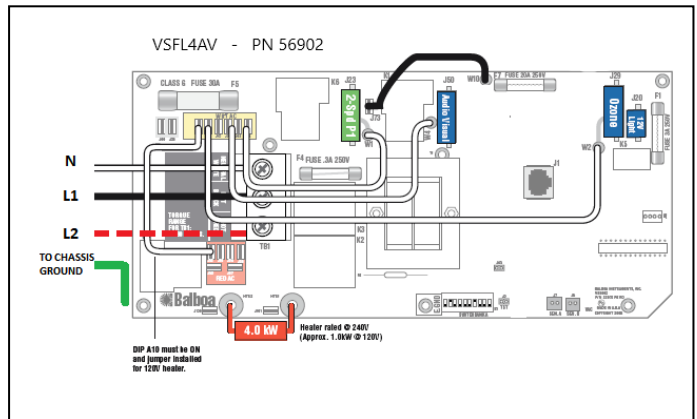

1. Remove and discard the 120-volt GFCI power cord.
2. Remove and discard the white wire jumper between J32 and J11.
3. Move #10 dip switch to proper position: low amp for a 30-amp service, or high amp for a 40-amp service. See page 10 to help with the decision.
4. When supplying the new 4 wire service, connect line 2 to the terminal indicated by the dotted line in the above diagram.

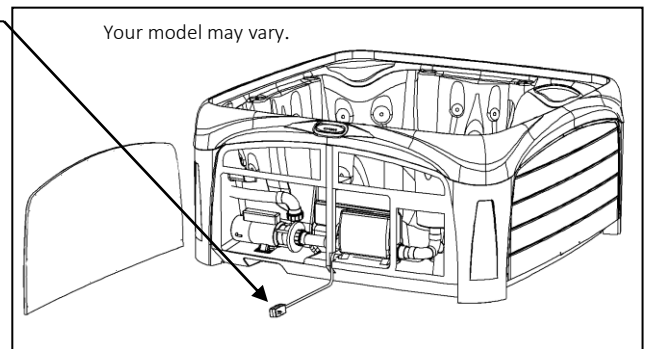

Additional wiring information:

GFCI PROTECTION: The new service must be protected with by a GFCI and a disconnect switch. The National Electrical Code requires that spas connected to 240 volts circuits be equipped with a GFCI and disconnect switch. See National Electric Code Articles 680-12 and 680-42. This spa is not equipped with a 240-volt GFCI or a disconnect switch. A GFCI must be installed by a certified licensed electrician.

OUTDOOR LOAD CENTER: The addition of an outdoor load center such as a Siemens W0408ML 1125 or equal must be added to the circuit. This type of load center provides both a GFCI and Disconnect Switch in a convenient configuration as required by the National Electric Code. (See next page for suggested wiring configuration)

ISOLATED, DEDICATED 240 VOLT, 30- OR 40-AMP CIRCUITS ARE REQUIRED An isolated, dedicated 240 volts, 30- or 40-amp circuit is required to provide the power necessary to properly operate the 240V equipment package.

PERMANENTLY HARD WIRED: All 240-volt operations wiring must be permanently hard wired, installed in grounded conduit and installed in compliance with the National Electrical Code and all local codes. Do not use an extension cord. Use of an extension cord will void the warranty.

WIRE SIZING MUST MEET ELECTRICAL CODES: All installations are different. Wire sizing must meet the National Electrical Code and all local code specifications.

See next two pages for more conversion details

FOR THE ELECTRICIAN, CONVERSION FROM 120V TO 240V continued
 ELECTRICAL DATA FOR THE USE OF CERTIFIED LICENSED ELECTRICIAN
 REQUIRED WIRING FOR 240 VOLT INSTALLATION **One-pump (PU1) models**
 All wiring **MUST** be in accordance with the National Electrical Code and all local codes.

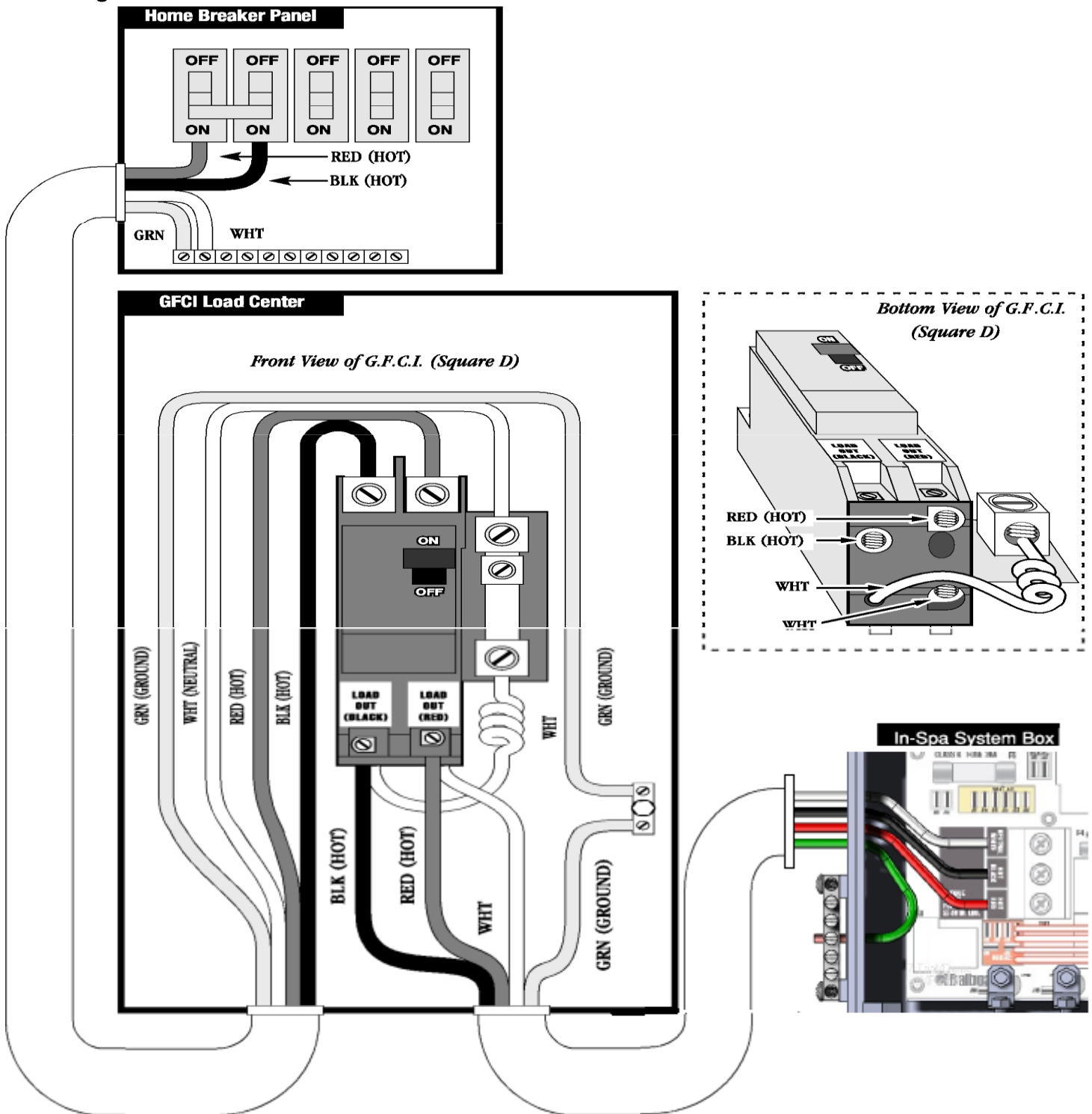

DIP SETTINGS VS3FL4AV 56902

WARNING: Shock Hazard! Under No Circumstances Should This Spa Be Installed By Anyone Other Than A Certified Licensed Electrician!

One Pump (PU1)

MAIN POWER TO SYSTEM MUST BE TURNED OFF BEFORE ADJUSTING DIP SWITCHES

<p>DIP SETTINGS</p> 	TEST MODE OFF	← 1	TEST MODE ON
	N/A MUST BE OFF	2 →	JET/LIGHT/TEMP DOWN/TEMP UP
	LT DUP OR DIGDUP PANEL	3 →	MINI PANEL
	N/A MUST BE OFF	← 4	N/A MUST BE OFF
	SEE PUMP TABLE	← 5	SEE PUMP TABLE
	60HZ OPERATION	← 6	50HZ OPERATION
	STD, ECON, SLEEP ALLOWED	7 →	STANDARD MODE ONLY
	DEGREES FAHRENHEIT	← 8	DEGREES CELSIUS
	SEE PUMP TABLE	← 9	SEE PUMP TABLE
	HIGH AMP – HEAT W/P1 HI	10 →	LOW AMP – NO HEAT W/P1 HI

PUMP TIMEOUTS TABLE

<u>Switch 5</u>	<u>Switch 9</u>	<u>Low speed</u>	<u>High speed</u>
<u>Off</u>	<u>Off</u>	<u>2 Hours</u>	<u>15 Minutes</u>
<u>On</u>	<u>off</u>	<u>2 Hours</u>	<u>30 Minutes</u>
<u>Off</u>	<u>On</u>	<u>15 Minutes</u>	<u>15 Minutes</u>
<u>on</u>	<u>On</u>	<u>30 Minutes</u>	<u>30 Minutes</u>

One-pump (PU1) models, System Operation

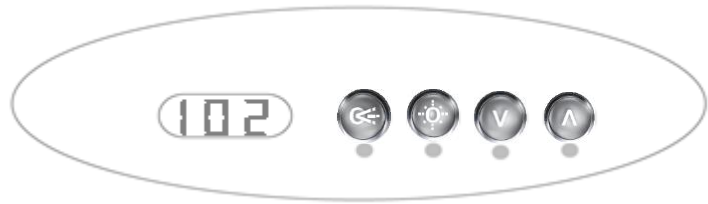

Initial Start-Up



When electrical power is first supplied to your spa, the control system will display a series of numbers followed by **Pr**, then -- --. At this point the circulation pump will be activated and operate for 7 minutes as it seeks to prime the pump. If the spa was filled as described on page 13, the pump will usually prime without a problem. However, if after 7 minutes, water is not flowing from the jets, you may need to purge the pump manually. Please see page 34 for how to manually purge the pump.

Please note that when electrical power is first supplied to the spa, the spas internal clock starts. This begins the first 12-hour period in which the selected filtration cycle will operate. The preset cycle is one hour (F1). Please see **Spa Water Maintenance**, below.



Also please note that upon initial start-up, temperature adjustment is preset to heat up to 100° F (37° C). Please see **Temperature Adjustment** below if you wish to choose a different setting.

Temperature Adjustment



The temperature adjustment range is 80° to 104° when displayed in Fahrenheit. When displayed in Celsius the range is 26° to 40°.

The control's display will constantly show the spa's water temperature. To adjust the spa's water temperature, press  or . The display will flash and show the current temperature setting. Each time either one of these buttons are pressed, the temperature setting will change by 1°. After you have set the desired temperature, stop pressing the buttons, the display will stop flashing after five seconds and the current spa temperature will show again.

Jets

Press the  pad to power the pump. The pump will sequence with each press of the  button as follows: low flow – high flow – off. If left running, the high flow pump will automatically turn off after 15 minutes (low flow in two hours). These time out durations can be adjusted. See page 20 for details.

Adjustable LED Light

To turn the light on, press the  button. Press again to turn it off. To adjust the color modes, press the  button immediately after turning it off. The light will come back on in a new color mode. Each time you repeat this procedure, the light will cycle to a new color mode, as shown below. If left on, the light will automatically turn off after four hours.

1. Color wheel. The light will slowly blend cycle through the colors.
2. Aqua white.
3. Light blue.
4. Violet.
5. Dark blue.
6. Light green.
7. Dark green.
8. Red.
9. Step sequence through the colors.
10. Very slow color wheel.
11. Back to #1.

Spa Water Maintenance

This function enables you to program the amount of water filtration time.

Press or then to enter the programming mode.

Once in the programming mode press or to select the filtration time: F1 through F8 per the chart below.

Code	F1	F2	F3	F4	F5	F6	F7	F8
Hours of filtering every 12 hours	1	2	3	4	5	6	7	8

To exit press .

Spa heating modes

Your spa is factory set to Standard Heating (ST) mode. This mode operates the heater whenever needed to maintain the programmed spa water temperature. (See Temperature Adjustment page 21).

Advanced Optional Settings

You have the option to enable other heating modes as explained below: standard, economy and sleep. To enable these heating modes, you must do the following steps.

1. Turn off power to the spa.
2. Using a Philips screwdriver, remove the equipment access panel as shown.
3. Remove the control box cover by removing the two bottom screws, slide the cover up and then pull forward.
4. Slide dip switch 7 to the *off* position. See page 17 for reference.
5. Reinstall the control box cover and the equipment access panel, before turning the power on.

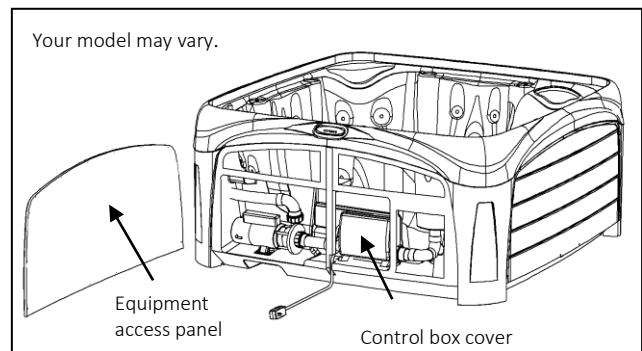

These heating modes offer the ability to control your heater in one of three ways: standard, economy or sleep. Your spa is preset at the factory to Standard Mode. However, the Standard Heating Mode can be changed to Economy or Sleep by pressing then . With each pressing of then , the display will cycle through the three different modes described below. Note: by pressing then , you will not see the heating mode the spa is currently set to, but rather it will advance to the next mode. It is the last mode seen in the display that will be the new heating mode setting.

- **Standard Mode (St):** Your spa is preset to this mode. This mode operates the heater whenever needed to maintain the programmed spa water temperature. (See Temperature Adjustment page 21).
- **Economy Mode (Ec):** This mode operates the heater only during programmed Filtering Cycles (See Spa Water Filtration Settings above). This mode is ideal for areas that charge a premium for electricity during peak hours. This mode will maintain the thermostat setting. If it does not reach the thermostat setting, you may have to allow for more heating time by increasing the filtration cycles.
- **Sleep Mode (SL):** This mode works in the same manner as the Economy Mode except the thermostat setting is automatically lowered by 20 degrees. This mode is best suited for extended leaves from home when it is not important to maintain constant water temperature, such as vacations or business trips.

Summer Set Temperature

In extremely hot weather, it is possible for water temperature to exceed the temperature setting. This is especially common when your temperature setting is lower than air temperature. If the water temperature exceeds the temperature setting more than 3°F (1.5°C), the pump will stop running automatically except during filter cycles. Normal operation will resume when the water temperature cools to below the setting, or the setting is increased above the water temperature.

Two-pump (PU2) models, System Operation

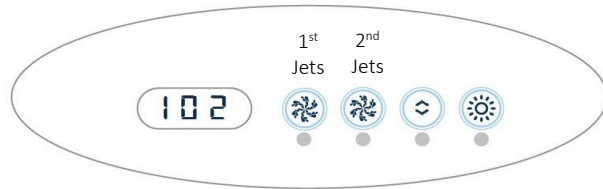

Initial Start-Up





When electrical power is first supplied to your spa, the control system will display a series of numbers followed by **Pr**, then **-- --**. At this point the circulation pump will be activated and operate for 7 minutes as it seeks to prime the pump. If the spa was filled as described on page 13, the pump will usually prime without a problem. However, if after 7 minutes, water is not flowing from the jets, you may need to purge the pump manually. Please see page 34 for how to manually purge the pump.

Please note that when electrical power is first supplied to the spa, the spas internal clock starts. This begins the first 12-hour period in which the selected filtration cycle will operate. The preset cycle is one hour (F1). Please see **Spa Water Maintenance**, below.

Also please note that upon initial start-up, temperature adjustment is preset to heat up to 100° F (37° C). Please see **Temperature Adjustment** below if you wish to choose a different setting.

Temperature Adjustment



The temperature adjustment range is 80° to 104° when displayed in Fahrenheit. When displayed in Celsius the range is 26° to 40°.

The control's display will constantly show the spa's water temperature. To adjust the spa's water temperature, press the  button. The display will show the current set temperature and flash. To change the set temperature, press the  button a second time before the display stops flashing. Each press of the  button will continue to either raise or lower the set temperature. If the opposite direction is desired, allow the display to revert to the current water temperature. Press the  button to display the set temperature, and again to make the temperature change in the desired direction. After you have set the desired temperature, stop pressing the  button, the display will stop flashing after five seconds and the current spa temperature will show again.



1st Jets

Press the 1st jets  button to power the 1st jet pump. Press again to turn it off. If left running, the high flow pump will automatically turn off after 15 minutes.

2nd Jets

Press the 2nd jets  button to power 2nd jet pump. This pump will sequence with each press of the 2nd jets  button as follows: low flow – high flow – off. If left running, the high flow pump will automatically turn off after 15 minutes (low flow in 4 hours).

Adjustable LED Light

To turn the light on, press the  button. Press again to turn it off. To adjust the color modes, press the  button immediately after turning it off. The light will come back on in a new color mode. Each time you repeat this procedure, the light will cycle to a new color mode, as shown below. If left on, the light will automatically turn off after four hours.

1. Color wheel. The light will slowly blend cycle through the colors.
2. Aqua white.
3. Light blue.
4. Violet.
5. Dark blue.
6. Light green.
7. Dark green.
8. Red.
9. Step sequence through the colors.
10. Very slow color wheel.
11. Back to #1.

Two-pump (PU2) models, Additional Functions

Spa Water Maintenance

This function enables you to program the amount of water filtration time.

Press  then the 2nd jets  button to enter the programming mode.

Once in the programming mode press  to select the filtration time: **F1** through **F8** per the chart below. **FC** In this mode the water will be filtered continuously.

Code	F1	F2	F3	F4	F5	F6	F7	F8
Hours of filtering every 12 hours	1	2	3	4	5	6	7	8

To exit press the 2nd jets  button.

Spa heating modes





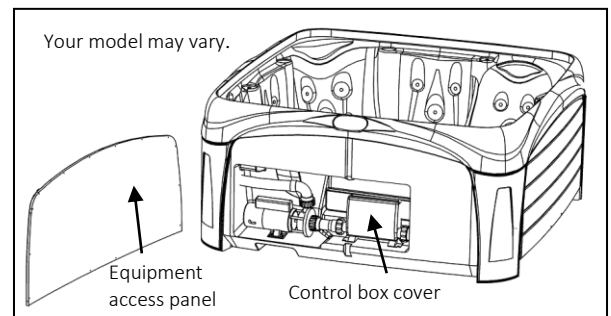

Your spa is factory set to Standard Heating (ST) mode. This mode operates the heater whenever needed to maintain the programmed spa water temperature. (See Temperature Adjustment page 23).

Advanced Optional Settings

You have the option to enable other heating modes as explained below: standard, economy and sleep. To enable these heating modes, you must do the following steps.

1. Turn off power to the spa.
2. Using a Philips screwdriver, remove the equipment access panel as shown.
3. Remove the control box cover by removing the two bottom screws, slide the cover up and then pull forward.
4. Slide dip switch 2 to the *off* position. See page 11 for reference.
5. Reinstall the control box cover and the equipment access panel, before turning the power on.



These heating modes offer the ability to control your heater in one of three ways: standard, economy or sleep. Your spa is preset at the factory to Standard Mode. However, the Standard Heating Mode can be changed to Economy or Sleep by pressing  then . With each pressing of  then , the display will cycle through the three different modes described below. Note: by pressing  then , you will not see the heating mode the spa is currently set to, but rather it will advance to the next mode. It is the last mode seen in the display that will be the new heating mode setting.

- **Standard Mode (St):** Your spa is preset to this mode. This mode operates the heater whenever needed to maintain the programmed spa water temperature. (See Temperature Adjustment page 23).
- **Economy Mode (Ec):** This mode operates the heater only during programmed Filtering Cycles (See Spa Water Filtration Settings above). This mode is ideal for areas that charge a premium for electricity during peak hours. This mode will maintain the thermostat setting. If it does not reach the thermostat setting, you may have to allow for more heating time by increasing the filtration cycles.
- **Sleep Mode (SL):** This mode works in the same manner as the Economy Mode except the thermostat setting is automatically lowered by 20 degrees. This mode is best suited for extended leaves from home when it is not important to maintain constant water temperature, such as vacations or business trips.

Summer Set Temperature

In extremely hot weather, it is possible for water temperature to exceed the temperature setting. This is especially common when your temperature setting is lower than air temperature. If the water temperature exceeds the temperature setting more than 3°F (1.5°C), the pump will stop running automatically except during filter cycles. Normal operation will resume when the water temperature cools to below the setting, or the setting is increased above the water temperature.

Display Messages

MESSAGE	MEANING	ACTION REQUIRED
	No message on display. Power has been cut off to the spa.	The control panel will be disabled until power returns. Spa settings will be preserved until next power up.
--	Temperature unknown.	After the pump has been running for one minute, the temperature will be displayed.
H H	Overheat -The spa has shut down. One of the sensors has detected 118°F (47°C) at the heater.	DO NOT ENTER THE WATER. Remove the spa cover and allow water to cool. Once the heater has cooled, reset by pushing any button. If spa does not reset, shut off the power to the spa and call your dealer or service organization.
O H	Overheat" -The spa has shut down. One of the sensors has detected that the spa water is 110°F (43°C).	DO NOT ENTER THE WATER. Remove the spa cover and allow water to cool. At 107°F (41°C), the spa should automatically reset. If spa does not reset, shut off the power to the spa and call your dealer or service organization
1 C	Ice -Potential freeze condition detected.	No action required. The pump will automatically activate regardless of spa status.
S A	Spa is shut down. The sensor that is plugged into the "A" jack is not working.	If the problem persists, contact your dealer or service organization. (May appear temporarily in an overheat situation and disappear when the heater cools.)
S b	Spa is shut down. The sensor that is plugged into the "B" jack is not working.	If the problem persists, contact your dealer or service organization. (May appear temporarily in an overheat situation and disappear when the heater cools.)
S n	Sensors are out of balance. If alternating with spa temperature, it may just be a temporary condition. If flashing by itself, spa is shut down.	If the problem persists, contact your dealer or service organization.
H L	A significant difference between temperature sensors has been detected. This could indicate a flow problem.	Check water level in spa. Refill if necessary. If the water level is okay, make sure the pumps have been primed. If problem persists, contact your dealer or service organization.
L F	Persistent low flow problems. (Displays on the fifth occurrence of "HL" message within 24 hours.) Heater is shut down, but other spa functions continue to run normally.	Follow action required for "HL" message. Heating capability of the spa will not reset automatically; you may press any button to reset.
dr	Possible inadequate water, poor flow, or air bubbles in the heater. Spa is shut down for 15 minutes.	Water level in spa. Refill if necessary. If water level is okay, make sure the pumps have been primed. Press any button to reset, or this message automatically will reset within 15 minutes. If problem persists, contact your dealer or service organization.
dY	Water detected in heater. (Displays on third occurrence of "DR" message.) Spa is shut down.	Follow action required for "dr" message. Spa will not automatically reset. Press any button to reset.

SKIMMER FILTER CLEANING OR REPLACEMENT OF THE FILTER CARTRIDGE



The spa's automatic surface skimmer filter is designed to remove floating debris and contaminants, such as body lotions, by drawing water through a specially formulated filter cartridge element. It is critical that this element be routinely cleaned.



To Clean or Replace the Filter Cartridge

1. **Disconnect the electrical power.** Never operate the spa without the filter cartridge in place. It is difficult to remove the filter cartridge while the water is flowing. Also, there is a risk that debris may be drawn into the plumbing system, damage the pump and void the warranty.
2. Remove the skimmer cover.
3. Remove the end nut by turning it counterclockwise.
4. Pull the filter cartridge straight up and out of the skimmer filter.
5. At this point you can either clean the filter cartridge filter or install a new filter cartridge. To clean the filter cartridge, take it to an area where the runoff drains to a sewer drain capable of safely assimilating the water which may contain both unsanitary contaminants and chemical residue. Thoroughly rinse with the high pressure from a garden hose until the filter cartridge is free of dirt and debris. Note, it is recommended the filter cartridge be replaced at least every 18 months.
6. Return the cleaned or new filter cartridge to the filter well and thread the end nut clockwise until snug against the top of the filter cartridge. Reinstall the skimmer cover before reconnecting the electrical power.

Air Injection Venturi Adjustment

Air injection into the jet's water stream is adjusted by turning the venturi dials. Each dial is independent and controls about half of the jets, respectively. Turn them counterclockwise to increase, and clockwise to decrease, the amount of air injected into the jets' water stream.



"2023-Crossover" models



Adjustable Water Flow Jets

The jet's water flow is adjusted by turning the jet face. Each jet's flow is adjusted independently. Turn the jet face clockwise to increase, and counterclockwise to decrease, the amount of water flow of each jet.

styles shown may vary.



Waterfall Flow Adjustment

Turn the dial counterclockwise to increase, and clockwise to decrease, the amount of water flow of the waterfall.

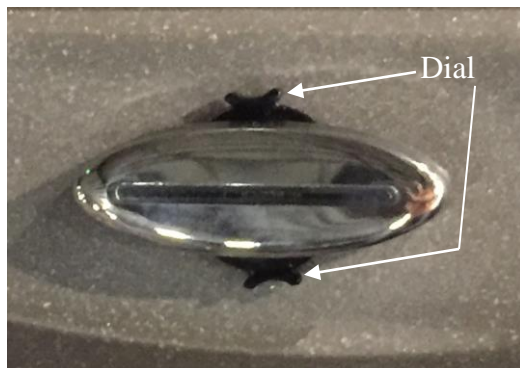

Aroma Infusions (only available on the “2023-Crossover” models)

- Listed below is a step-by-step guide how to use the Aroma Infusions feature



HOW TO RELEASE SCENT INTO SPA

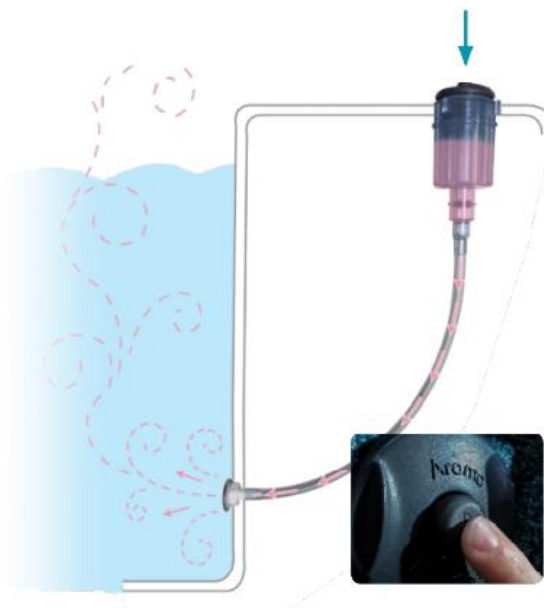

Pop-up fountains & On / Off valve (only available on the "2023-Crossover" models)

The Pop-up fountains are adjusted by turning the On / Off valve counterclockwise to increase, and clockwise to decrease the output of the water stream

On / Off valve



Pop-up fountains (closed position)



Pop-up fountains (fully open position)



Water Chemistry

Spa water chemistry (or water balance) affects the safety of your equipment as well as the appearance of your spa water. Water balance has five factors: pH, total alkalinity, calcium hardness, temperature and total dissolved solids. The pH is the most critical but total alkalinity and calcium hardness must also be watched closely. Low calcium hardness can lead to corrosion of equipment, while high calcium hardness can lead to scaling, cloudy water and staining. Water temperature should never exceed 104°F (40°C), and total dissolved solids should be kept below 1500 PPM.

Algicidal and sanitizing chemicals are either alkaline or acid. Sodium and calcium hypochlorites are alkaline. Chlorine gas and practically all other dry chlorine spa products are acid. On the market are several bromine sanitizers. Bromines are usually preferred since they don't emit a strong chlorine odor.

SEE YOUR SPA WATER EXPERT FOR ADDITIONAL INFORMATION

Damage due to improper chemistry will void warranty

1. Check and adjust water conditions. You must maintain proper chemical balance to ensure safe conditions, do not allow your spa to become a breeding place for bacteria. This is done by:
 - A. Test daily and maintain pH between 7.2 and 7.8. Adjust, if necessary, above 7.8 use pH decrease, if below 7.2 use pH Increase. Improper pH can damage spa finish, equipment, cause eye irritation and chemical loss. Use dosage according to manufacturer's label.
 - B. Test alkalinity and maintain at 80 ppm to 140 ppm. Adjust, if necessary, above 140 ppm use pH Decrease, if below 80 ppm use Total Alkalinity Control. Use dosage according to manufacturer's label.
 - C. Test daily and maintain proper sanitizer level. It's recommended to use bromine sanitizer and maintain bromine at 3.0 to 5.0 ppm. Typically, two or three bathers relaxing in an average spa with 103°F (39.4°C) temperature will consume all the bromine sanitizer in about twenty minutes. Therefore, prolonged or heavy use may require additional bromine to maintain sanitary conditions.
 - D. "Shock" (with a non-chlorine shock) once a week and after each water change. Do not use spa until the bromine residual has dropped to less than 5.0 ppm. NOTE: Improper pH will cause early corrosion to your pump. Corrosion is not handled under any warranty.

SPA MAINTENANCE SCHEDULE

DAILY

Test and maintain pH: Ideal range 7.2 - 7.8b.

Test and maintain bromine: Ideal range 3.0 - 5.0 ppm.

WEEKLY

Test and maintain alkalinity 80 - 140 ppm. Shock with a non-chlorine shock.

Add Spa Clear.

MAINTENANCE

Add defoamer as needed.

Inspect filter cartridge every 2 weeks and clean when needed.

Replacing the LED Light

1. Disconnect electrical power to the spa.

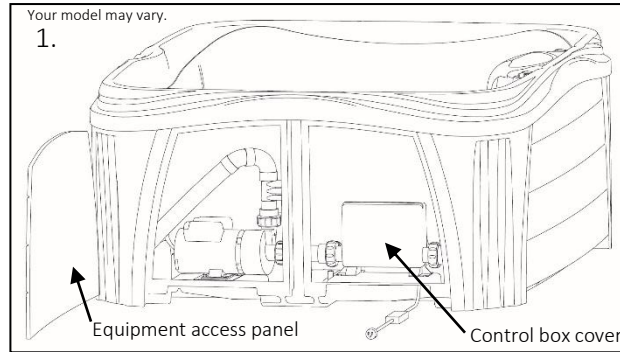

2. Remove the cabinet access panel behind the light and the access panel to the spa control box.

3. Remove the control box cover, locate the light connector and unplug it from the receptacle.

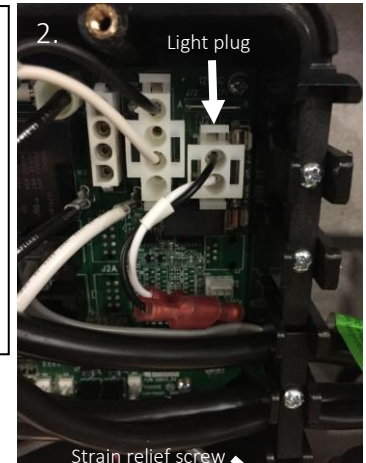

4. Remove the cord strain relief by removing the screw.

5. Locate and turn the light holder counterclockwise and remove from the wall mounted clear lens.

6. Unplug the daisy chain connectors.

7. While grasping the light holder, turn the light clockwise a quarter turn to free it from the holder.

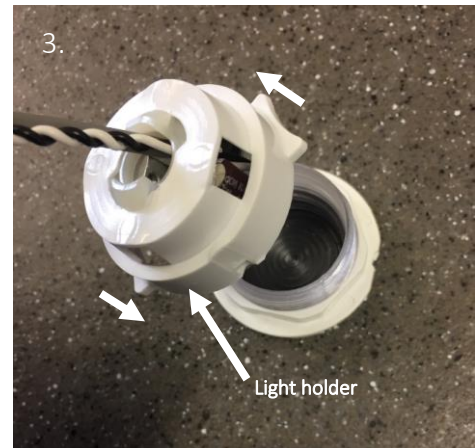

8. Pull the light cord all the way through the holder.

9. Route the replacement light's cord from the light lens, through the holder and to the control box. Install by reversing steps 7 through 1.

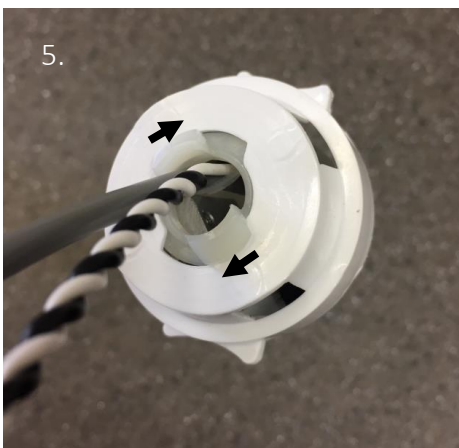

Headrest Installation

Your headrests are designed to not be removed. However, if you need to reinstall the headrest on the spa, follow these steps.

1. Using a Phillips screwdriver, remove the cabinet panel(s) directly behind the headrest location.
2. Locate the two wing nuts and completely remove them turning counterclockwise (Fig 10).
3. Remove the two clear threaded fittings and insert their heads into the two outside holes in the back of the headrest (Fig 11). Using a hair blow dryer, heating the plastic around the holes first, may help this step, but is not required.
4. Insert the two clear threaded fittings into the corresponding holes in the spa shell (Fig 12).
5. Turn the wing nuts clockwise until they pull the headrests against the spa shell. Hand tight is sufficient.
6. Reinstall the panels.

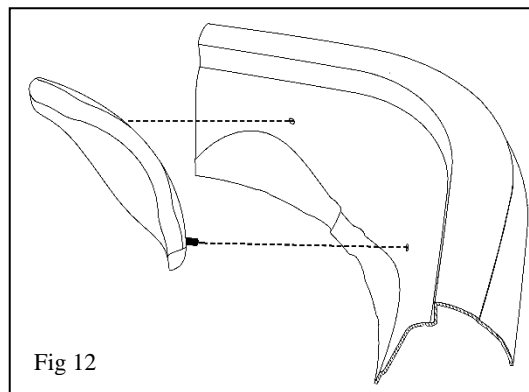
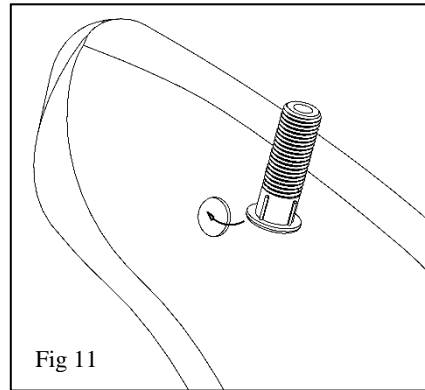
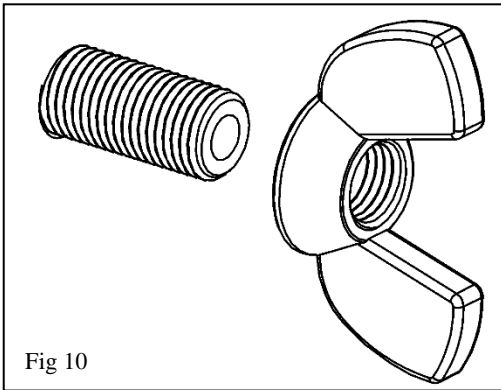

Freeze Protection

DO NOT ALLOW THE SPA TO FREEZE

Caution, any damage caused by improper winterizing will void the warranty. You may want to consider contacting a spa professional for winterizing service.

If the spa is to be stored or transported in temperatures of 32°F (0°C) or lower, it is critical that the unit be fully winterized.

To winterize the spa, follow these steps:

1. The spa itself must be completely drained of water. See page 14 for draining instructions.
2. The drain valve must be in the open position and the cap removed.
3. Drain the pump by removing the pump wet end drain plug (Fig 13). Leave this plug out until it is time to refill the spa. (Your pump model may vary.)

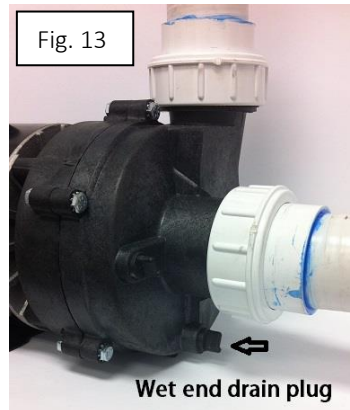

4. The filter cartridge must be removed, dried and stored. See page 26 for instructions for removing the filter cartridge.
5. The spa must be inverted (turned upside down) for at least five minutes to facilitate draining of the internal plumbing.

CLEANING YOUR SPA

Do not use cleaners or compounds containing harsh abrasives. Also, avoid using heavy-duty rubbing or buffing compounds. Use a soft liquid cleaner.

CARE OF WEATHERSHIELD COVER

Weather Shield is designed to be easy to maintain. It can be washed or brushed off and rinsed. Proper care and cleaning are important to the life of all fabrics.

FOR NORMAL CARE AND CLEANING. Add 2 ounces of mild soap such as Woolite or Dawn dishwashing liquid to 1 gallon of lukewarm water. Clean the fabric with a "soft bristle brush. Rinse thoroughly with cold water and air dry.

Frequently Asked Questions

- Why does my spa not shut off?** Your spa is designed to run from the time you plug it in, until it reaches your desired water temperature. Once desired water temperature is reached then you can control the functions with the buttons on the top control. For example: On the initial startup the spa will run for up to 18 hours to reach 100°F (38°C). At that point the spa will shut off, and then the spa will maintain your desired temperature settings. Keep in mind that anytime power is disrupted to the spa, the spa will reset itself and run until it reaches the spa's default settings.
- Why does my spa turn on late at night?** The spa is designed to filter every 12 hours. The clock starts the second you plug it in. Recommend unplugging and plugging back in between 7 and 8. This means the spa will come on every 12 hours at the designated time and filter the amount of time you have it set for.
- Why is my spa not heating?** Spas heat at approximately 1.5°F (0.8°C) or more per hour. If your water temperature is 70°F (21°C) when you first fill your spa it will take up to about 20 hours to reach 100°F (38°C). Remember, it is imperative to keep your safety cover on and the air injection dials turned off while heating.

4. How many gallons does my spa hold?

First three characters on rating plate Model No	JS2, SS2, LS2, FS2	JC2, SC2, LC2, FS2, DQ2, TQ2	JC3, SC3, LC3, FC3	CS2, DQ3, TQ3	CS3	AC2	AC3
Liters	969	1155	1264	1189	1245	1340	1390
Gallons	256	305	334	314	329	354	367

- I see water on the floor. What does this mean?** The cover can accumulate condensation between the seams and run down the sides of the spa. You can verify that water is coming from the cover by squeezing the seam, or by repositioning the cover so that the seam is on a different side. This only occurs when the temperature and humidity are at certain levels.

PURGING THE PUMP

Sometimes after a water change (draining and refilling the spa), or initial start-up of the spa, there is no water flowing from the jets. You may hear the pump operating or even see the shaft of the pump motor turning but have no water flowing from the jets. In addition to no flow out of the jets, you may even see an error message dr, dY, HH, OH, HL, or LF. All these error messages can be caused by a lack of water flow. When this happens, there is probably an airlock in the pump. This airlock must be purged from the plumbing for the pump to operate normally.

To purge the pump, please follow these steps:

1. Ensure the spa is filled 6 to 8 inches (15 to 20 cm) below the top of the spa.
2. Remove the service panel to expose the water pump. Fig 14

Your model may vary

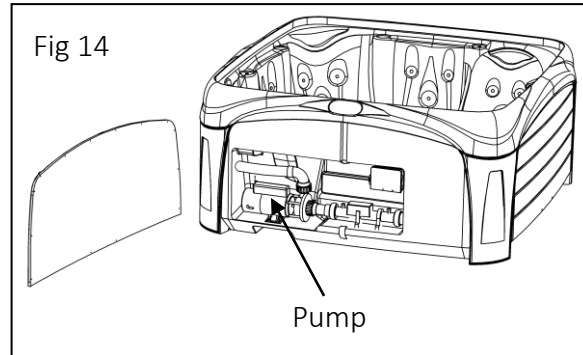

The pipes entering and leaving the pump are connected with large plastic unions. To purge the air from the pump, one of these unions will be slightly loosened.

3. Place a towel under the union to be loosened.
4. Using large pliers, slightly turn the union nut counterclockwise (Fig 15). This will produce a faint hissing sound of the trapped air escaping the pump. This will be followed by a small squirt of water which signals it is time to close the union by turning it back (clockwise). Do not over tighten the union. It is designed to be hand tight.

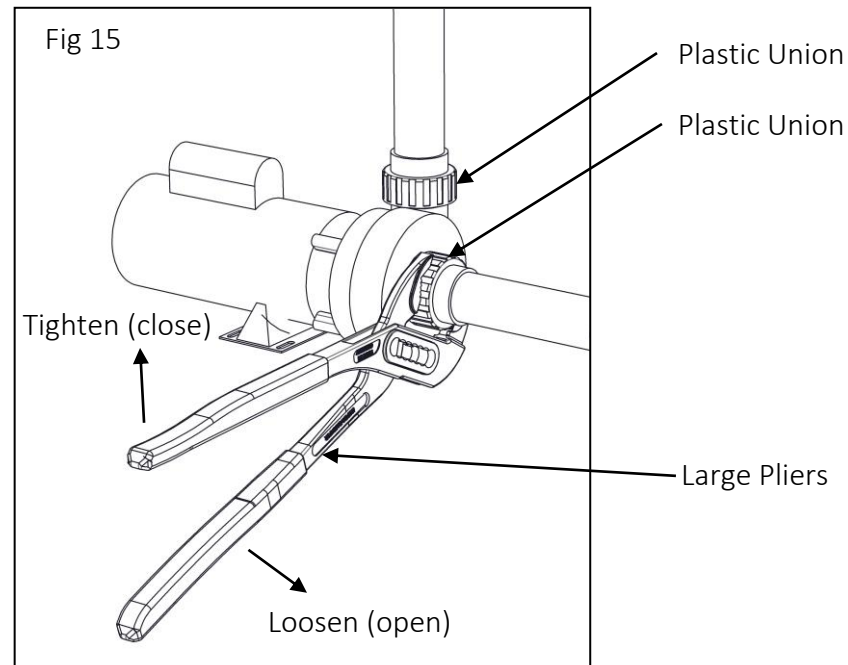

Troubleshooting Guide

SITUATION	PROBABLE CAUSE	ACTION
NO HEAT OR HEAT TOO LOW	Operating while spa cover is open.	Ensure that spa cover is properly closed.
	Dirty filter	Replace or clean filter cartridge. Pg. 26
JETS WON'T COME ON	No power to spa control.	Check the GFCI, circuit breaker and/or disconnect switch.
NO CONTROL DISPLAY OR FUNCTIONS	No power to spa control.	Check the GFCI, circuit breaker and/or disconnect switch.
LOW WATER FLOW	Dirty filter.	Replace or clean filter cartridge. Pg. 26
	Low water level.	Make sure water level in spa is correct.
NO AIR BUBBLES IN JET	Air control valve in the closed position.	Open venturi dials. Pg. 27.
SPA IS LEAKING	Spa drain valve and cap partially open.	Ensure that drain valve and cap are fully closed. Pg. 14
NO SPA LIGHT	Burned out bulb.	Replace bulb. Pg. 30
SLOW WATER DRAIN	Drain valve not fully opened.	Ensure that valve is fully open. Pg. 14
	Dirty filter.	Remove filter cartridge and clean. Pg. 26
	Kinked garden hose	Ensure drain hose is not kinked and is in a downhill direction.
NO WATER FLOW FROM JETS	Air lock in pump	Purge the pump. Pg. 34

Glossary of Terms

VENTURI DIALS

Mounted on the lip of the spa or at the equipment shroud, to induce air to the jets.

BYPASS CHECK VALVE

Prevents water flow stoppage due to dirty filter.

CONTROL BOX

Basically, the brain of the spa. Power is distributed to all functions of the spa, pumps, lights, heat, etc.

DRAIN VALVE

Used in the draining of the spa, looks like an outdoor faucet and fits a standard garden hose.

FILTER

The filter cleans the spa and removes particles and debris and protects the equipment from foreign substances.

FOOTWELL

The bottom of a spa where you place your feet.

GFCI PLUG

The electronic switch installed at the end of the power cord to connect to an electrical wall outlet.

HEATER

The thermostatically controlled heater raises the temperature of the water to the desired degree. This is located under the control box in the equipment area.

JETS

The fittings on your spa that direct the flow of water for massaging action.

pH

Stands for "Potential for Hydrogen" This is the term used to describe the acid (low pH) or alkalinity (high pH) condition of the water. The ideal pH for spa water is 7.5.

SKIMMER

The skimmer removes surface debris to the filter. The water level in the spa should be kept at the proper range for optimum skimmer operation.

TOP CONTROL PANEL

Mounted on the lip of the spa. The digital panel that controls the spas functions.

Ozone

Your spa may have an ozone generator as standard equipment and will not show in the “option” box of the rating plate. If ozone is an option for your model and you ordered your spa with the optional ozone installed, you can confirm this by viewing the spa’s rating plate. The rating plate is located near the floor and equipment access panel. As shown below, look in the “option” box to confirm the ozonator has been installed. The word “OZONE” will be seen.

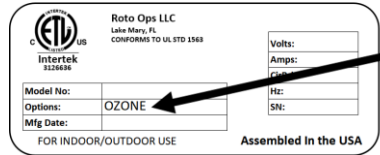

Further to verifying the ozone is installed on your spa. If you look in the equipment compartment you will see a small black or blue box, about 2.6 inches by 3.3 inches x 1.3 inches (6.6cm x 8.4cm x 3.3cm). It will be either strapped to the plumbing or mounted on a wall, as shown below.

