



OWNER'S MANUAL





## CERTIFICATE OF AUTHENTICITY

Thank you for your purchase. This certificate hereby verifies that the spa you have purchased from an Artesian Spas (May Manufacturing, LLC) authorized dealer is authentic, brand new and original. The spa has been crafted and built in the U.S.A in accordance with industry quality standards.

### WARRANTY REGISTRATION

Please activate your warranty and register your spa at [www.TidalFit.com](http://www.TidalFit.com) click on owner login or mail the registration card in the back of the owner's manual.

Spa Serial # \_\_\_\_\_

Spa Model: \_\_\_\_\_

Date Purchased: \_\_\_\_\_

Installation Date: \_\_\_\_\_

Dealer Name: \_\_\_\_\_

Telephone #: \_\_\_\_\_





# TABLE OF CONTENTS

---

Certificate of Authenticity.....	
Important Safety Instructions.....	1
Electrical Requirements and Installation.....	6
Electrical Wiring.....	6
GFCI Protection.....	7
GFCI Test Trip Procedure.....	7
60 Hz GFCI Wiring Schematic (EP-16).....	8
60 Hz Res. Wiring Schematic (EP-12/EP-14/EP-15)	9
50 Hz GFCI Wiring Schematic	9
Frequency Drive Wiring Diagramme (EP-16).....	10
TidalFit Specifications.....	11
TidalFit Semi In-Ground Arch Specs (EP-12/EP-14/EP-15).....	12
TidalFit Semi In-Ground Instructions	15
TidalFit Start Up.....	17
Selecting a Location.....	17
Inspection.....	18
Filling the TidalFit with Water.....	18
Turning the Power On.....	18
Verifying Water Circulation.....	19
Testing the GFCI Breaker.....	19
Priming the Pump.....	20
Water Preparation.....	20
Topside Control Instructions (EP-15).....	21
The Main Screen.....	21
Spa Operations.....	21
Temperature Operation.....	24
The Settings Screen.....	25
Temp Range.....	26
Heat Mode.....	26
Ready Mode.....	27
Rest Mode.....	27
Time of Day.....	28
Setting Filter Cycle	29
Invert Display.....	32
Restricting Operations (Lock).....	33

# TABLE OF CONTENTS

---

Hold.....	35
Utilities.....	35
Preference.....	36
Time Display.....	36
Dolphin (Not Used).....	37
Color.....	37
Language.....	37
Heater Related Messages.....	38
Sensor Related/Misc. Messages.....	39
Sensor Related Messages.....	39
Miscellaneous Messages.....	39
System Related Messages.....	40
Reminder Messages.....	41
<b>Swimspeed Control Instructions (EP-16).....</b>	<b>42</b>
Maintenance.....	42
Required Voltage For Control Box.....	42
Hydraulic Water Current Motor.....	42
<b>Diagnostic Messages.....</b>	<b>43</b>
<b>Periodic Reminder Messages.....</b>	<b>47</b>
<b>Various Exercises.....</b>	<b>48</b>
Rowing Exercise.....	48
Upper Body Workouts.....	49
Treadmill/Advanced Swimming w/Super Swim.....	50
<b>Maintaining Your TidalFit.....</b>	<b>51</b>
Draining Your TidalFit.....	51
Pillow Care.....	51
Jet Care.....	52
Removing, Installing, and Cleaning Filters.....	53
Winterizing Your TidalFit.....	53
Replacing the Light Bulb.....	54
TidalFit Cabinet Care.....	54
Cleaning Your TidalFit Interior.....	55
Cover Care.....	55
Chemical Treatment of Water.....	56
<b>TidalFit Warranty .....</b>	<b>57</b>
<b>Interior Spa Diagram.....</b>	<b>63</b>
<b>TidalFit Parts List.....</b>	<b>65</b>

# IMPORTANT SAFETY INSTRUCTIONS

---

**PLEASE TAKE THE TIME TO READ ALL OF THESE WARNINGS AND CAUTIONS PRIOR TO USING YOUR SPA.**

PLEASE, be a responsible spa owner. When installing and using this spa, always adhere to basic safety precautions. Be sure to list emergency telephone numbers at the telephone nearest the spa, including physician, hospital, ambulance, police, and the fire department. Be certain to explain safety precautions to all new or occasional users of your spa. Remember, they may not be aware of the possible risks associated with the spa water temperature. Have at least one family member learn CPR (cardiopulmonary resuscitation). **IT COULD SAVE A LIFE!**

## READ AND FOLLOW ALL INSTRUCTIONS

1. **WARNING** - To reduce the risk of injury, do not permit children to use this product unless they are closely supervised at all times.

2. A wire connector is provided on this unit to connect a minimum 8 AWG (8.4 mm) solid copper conductor between this unit and any metal equipment, metal enclosures of electrical equipment, metal water pipe, or conduit within 5 feet (1.5 m) of the unit.

3. For cord connected/convertible units. **DANGER - Risk of Injury** -

a) Replace damaged cord immediately.

b) Do not bury cord.

c) Connect to a grounded, grounding type receptacle only.

4. **DANGER - Risk of Accidental Drowning** - Extreme caution must be exercised to prevent unauthorized access by children. To avoid accidents, ensure that children cannot use this spa unless they are supervised at all times.

5. **DANGER - Risk of Injury** - The suction fittings in this area are sized to match the specific water flow created by the pump. Should the need arise to replace the suction fittings or the pump, be sure the flow rates are compatible.

Never operate spa if the suction fittings are broken or missing. Never replace a suction fitting with one rated less than the flow rate marked on the original suction fitting.

6. **DANGER - Risk of Electrical Shock** - Install at least 5 feet (1.5 m) from all metal surfaces. As an alternative, a spa may be within 5 feet of metal surfaces if each metal surface is permanently connected by a minimum 8 AWG (8.4 mm) solid copper conductor to the wire connector on the terminal box that is provided for this purpose.

# **IMPORTANT SAFETY INSTRUCTIONS**

---

7. **DANGER - Risk of Electric Shock** - Do not permit any electrical appliance such as a light, telephone, radio, or television, within 5 feet (1.5m) of a spa.

8. **WARNING - To reduce the risk of injury:**

a) The water in a spa should never exceed 40°C (104°F). Water temperatures between 38°C (100°F) and 40°C are considered safe for a healthy adult. Lower water temperatures are recommended for young children and when spa use exceeds 10 minutes.

b) Since excessive water temperatures have a high potential for causing fetal damage during the early months of pregnancy, pregnant or possibly pregnant women should limit spa water temperatures to 38°C (100°F).

c) Before entering a spa, the user should measure the water temperature with an accurate thermometer since the tolerance of water temperature-regulating devices varies.

d) The use of alcohol, drugs, or medication before or during spa use may lead to unconsciousness with the possibility of drowning.

e) Obese persons and persons with a history of heart disease, low or high blood pressure, circulatory system problems, or diabetes should consult a physician before using a spa.

f) Persons using medication should consult a physician before using a spa since some medication may induce drowsiness while other medication may affect heart rate, blood pressure, and circulation.

## **SAVE THESE INSTRUCTIONS**

### **EQUIPMENT ASSEMBLIES**

---

An equipment assembly shall be additionally provided with the following important safety instructions

1. **WARNING** - Risk of Accidental Drowning. Extreme caution must be exercised to prevent unauthorized access by children. To avoid accidents, ensure that children cannot use a spa or hot tub unless they are closely supervised at all times.

2. **DANGER** - To reduce the risk of drowning from hair and body entrapment, install a suction fitting(s) with a marked flow rate that equals or exceeds the flow rate marked on the equipment assembly.

3. **DANGER** - To reduce the risk of injury, do not remove the suction fittings. Never operate a spa or hot tub if the suction fittings are broken or missing. Never replace a suction fitting with one rated less than the flow rate marked on the equipment assembly.



# **IMPORTANT SAFETY INSTRUCTIONS**

---

4. **DANGER**- Risk of Electric Shock. Do not permit any electric appliance, such as a light, telephone, radio, or television, within 5 feet (1.5m) of a spa or hot tub.

5. **WARNING** - Risk of Electric Shock. Install at least 5 feet (1.5m) from inside wall of hot tub or spa using nonmetallic plumbing.

6. **WARNING** - To reduce the risk of injury:

a) The water in a spa should never exceed 40°C (104°F) Water temperatures between 38°C (100°F) and 40°C are considered safe for a healthy adult. Lower water temperatures are recommended for young children and when spa use exceeds 10 minutes.

b) Since excessive water temperatures have a high potential for causing fetal damage during the early months of pregnancy, pregnant or possibly pregnant women should limit spa water temperatures to 38°C (100°F).

c) Before entering a spa or hot tub, the user should measure the water temperature since the tolerance of water temperature regulating devices varies.

d) The use of alcohol, drugs or medication before or during spa or hot tub use may lead to unconsciousness with the possibility of drowning.

e) Obese persons and persons with a history of heart disease, low or high blood pressure, circulatory system problems, or diabetes should consult a physician before using a spa.

f) Persons using medication should consult a physician before using a spa or hot tub since some medication may induce drowsiness while other medication may affect heart rate, blood pressure, and circulation.

## **7. For equipment assemblies with a gas heater**

**WARNING** - Risk of suffocation. This equipment assembly uses a gas heater and is intended for outdoor use only unless proper ventilation can be provided for an indoor installation.

## **8. For equipment assemblies with a blower**

**WARNING** - Install blower no less than 1 foot (305mm) above the maximum water level to prevent water from contacting electrical equipment.

# **SAVE THESE INSTRUCTIONS**

# IMPORTANT SAFETY INSTRUCTIONS

## Marking for equipment assemblies

 <b>WARNING</b>
<b>REDUCE THE RISK OF ELECTROCUTION</b> <ol style="list-style-type: none"><li>1. Install at least 5 feet from water using nonmetallic plumbing.</li><li>2. Do not install under spa skirt or within an enclosure that would restrict ventilation.</li><li>3. If blower is included, install at least 1 foot above maximum water level.</li></ol>
<b>REDUCE THE RISK OF CHILD DROWING</b> <ol style="list-style-type: none"><li>1. Supervise children at all times.</li><li>2. Attach spa cover after each use.</li><li>3. Install a suction guard with marked flow rate no less than ____ GPM to avoid hair and body entrapment.</li></ol>
<b>REDUCE THE RISK OF OVERHEATING</b> <ol style="list-style-type: none"><li>1. Check with a doctor before use if pregnant, diabetic, in poor health, or under medical care.</li><li>2. Exit immediately if uncomfortable, dizzy or sleepy. Spa heat can cause hyperthermia and unconsciousness.</li><li>3. Spa heat in conjunction with alcohol, drugs, or medication can cause unconsciousness.</li></ol>
<b>WHEN PREGNANT</b> , soaking in hot water for long periods can harm your fetus. Measure water temperature before entering. <ol style="list-style-type: none"><li>1. Do not enter spa if water is hotter than 100°F (38°C).</li><li>2. Do not stay in spa for longer than 10 minutes.</li></ol>

## AUDIO COMPONENT WARNINGS

**Spas equipped with the Audio system should follow these guidelines for safety:**

1. **CAUTION** - Risk of Electrical Shock - Do not leave compartment door open.
2. **CAUTION** - Risk of Electrical Shock - Replace components only with identical components.
3. Do not operate the audio controls while inside the spa.
4. **WARNING - Prevent Electrocution** - Do not connect any auxiliary components (for example cable, additional speakers, headphones, additional audio/video components, etc.) to the system.
5. These units are not provided with an outdoor antennae; when provided, it should be installed in accordance with Article 810 of the National Electrical Code, ANSI/NFPA 70.
6. Do not service this product yourself as opening or removing covers may expose you to dangerous voltage or other risk of injury. Refer all servicing to qualified service personnel.

# **IMPORTANT SAFETY INSTRUCTIONS**

---

7. When the power supply connections or power supply cord(s) are damaged; if water is entering the audio/video compartment or any electrical equipment compartment area; if the protective shields or barriers are showing signs of deterioration; or if there are signs of other potential damage to the unit, turn off the unit and refer serviceing to qualified service personnel.

8. This unit should be subjected to periodic routine maintenance (for example, once every 3 months) to make sure that the unit is operating properly.

**KEEP THESE SAFETY INSTRUCTIONS IN A CONVENIENT AND READILY ACCESSIBLE LOCATION!!**

# ELECTRICAL REQUIREMENTS AND INSTALLATION

---

The following information is provided for hooking up electrical supply to your new pool. A qualified, licensed, electrician must perform this work. Failure to follow these instructions will terminate all warranty coverage and can cause serious injury or death.

Your 60Hz pool is preset at the factory to run on 240V with a 48 amp input. This feature gives you the most performance out of your pool. This will require a 240V, 60-amp GFCI

Your export 50Hz pool is preset out of factory to run 230V-240V 3 wires 30 amp max input. This product must always be connected to residual current device (RCD) having a trip current of not more than 30 mA.

## ELECTRICAL WIRING

---

**WARNING: Your pool must be wired by a certified electrician and according to these instructions. Failure to do so will terminate all warranties and all listings from the independent listing facility.**

1) The TidalFit requires a 240 VAC dedicated system. The pool must be hard wired to the power supply, with no plug-in connections, extension cords, or sharing of service.

2) The pool requires that you run 6 (10 mm<sup>2</sup>) or 8 (8.4 mm<sup>2</sup>) AWG copper wire, depending on the GFCI size. Do Not Use Aluminum Wire.

3) The power supply must have a suitable Ground Fault Circuit Interrupter (GFCI), according to Section 422-20 of the National Electrical Code, ANSI/NFPA 70-7987 or other national installation requirement with a residual current device (RCD) having a trip current of not more than 30 mA. This could be used as the shut-off switch, which must be installed in plain view of the pool. This electrical service must be readily accessible to the pool occupants, but must not be within 5 feet of the pool.

4) Use only non-metallic conduit and fittings when installing power to the spa.

5) After your pool has been positioned, route lines through the knockout on the left or right front corner of the pool.

6) Connect the power to the pool.

# ELECTRICAL REQUIREMENTS AND INSTALLATION

## GFCI PROTECTION

**NOTE:** The GFCI section does not apply on EL systems used outside the United States. This GFCI section does not apply to GL Systems.



Your pool may be equipped with a GFCI Protection feature. If your pool does not have this feature enabled, the GFCI Trip Test must occur to allow proper pool function.

Within 1 to 7 days after startup, the pool will trip the GFCI to test it. (The number of days is factory programmed.) The GFCI must be reset once it has been tripped. After passing the GFCI Trip Test, subsequent GFCI trips will indicate a ground default or other unsafe condition requiring the power to the pool to be shut off.



**Warning:** The owner should test and reset the GFCI on a regular basis to verify it's function

## GFCI TRIP TEST PROCEDURE

The installer can cause the GFCI Trip Test to occur sooner by initiating it with the following button sequence.

Press "Warm",  then "Jets 1",  then "Light." 



(Each press must be within 3 seconds of the previous press.) Press the "Warm" button repeatedly until "**9FC**" is displayed.

Press "Jets 1"  to select it. Press the "Warm"  button until "**9t.n**" is displayed. 

Press "Jets 1"  to initiate the GFCI Trip Test.

The GFCI should trip within several seconds and the pool should shut down. If it does not, shut down the power and manually verify that a GFCI breaker is installed and that the circuit and pool are wired correctly. Verify the function of the GFCI with it's own test button. Restore power to the pool and repeat the GFCI Trip Test.

Once the GFCI is tripped by the test, reset the GFCI and the pool will operate normally from that point. You can verify a successful test by navigating to the "**9FC**" item as described above, pressing

"Jets 1"  and then pressing the "Warm"  button until you see "**9SP**". The code signifies GFCI Status - Passed.

The system will exit this menu in 30 seconds if no buttons are pressed.

# 60 Hz GFCI WIRING SCHEMATIC (EP-16)

240 Volt Residential Wiring Schematic with G.F.C.I.

House Breaker Box G.F.C.I. Breaker Box

VFD Control Box

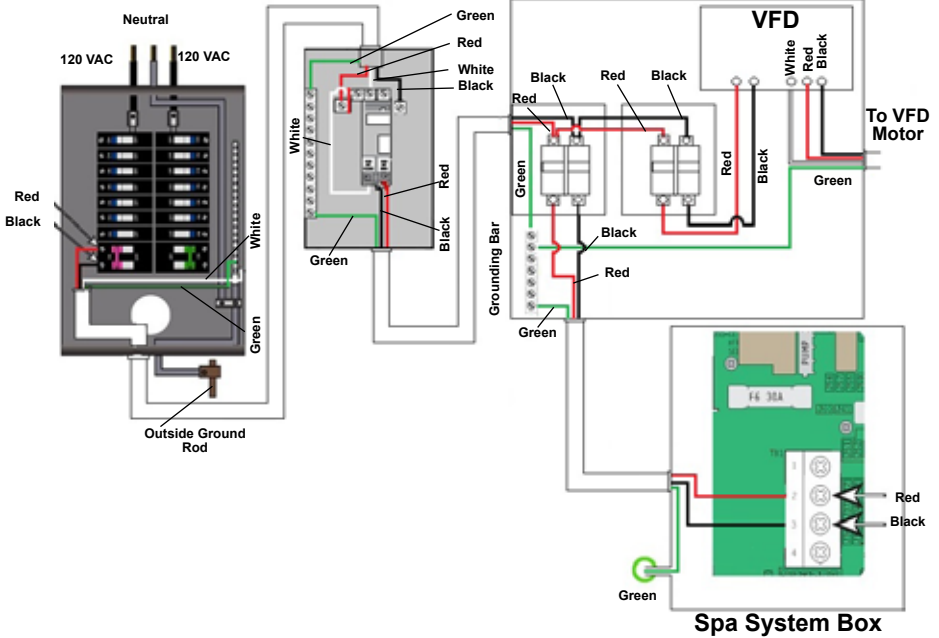

**NOTE:** THE POWER IN TO THIS CONTROL DOES NOT HAVE A COMMON LINE IN, ONLY A GROUND. DO NOT HOOK A COMMON TO A POWER IN TERMINAL! THIS WILL DAMAGE THE UNIT

**IMPORTANT:** REQUIRED SIEMENS 60A GFCI CIRCUIT BREAKER TO OPERATE THE TIDALFIT EP-16

# 60 Hz GFCI WIRING SCHEMATIC (EP-12/14/15)

## 240 Volt Residential Wiring Schematic with G.F.C.I.

### House Breaker Box

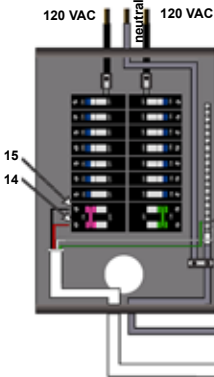

### G.F.C.I. Breaker Box

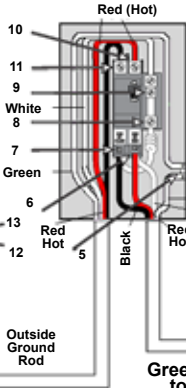

### Spa System Box

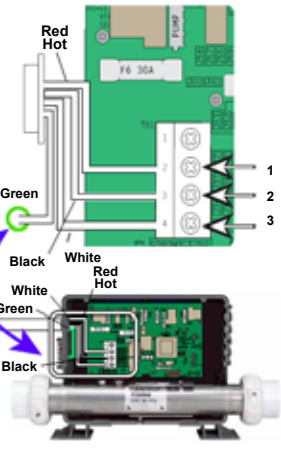

Correct Voltage	When Probes Are Placed			
0v	[3-4]	[5-8]	[5-9]	[12-13]
108V-132V	[1-3]	[5-6]	[5-10]	[12-14]
	[2-3]	[5-7]	[5-11]	[12-15]
216V-264V	[1-2]	[6-7]	[10-11]	[14-15]

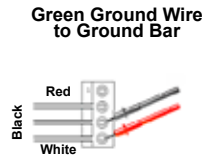

Test for Voltages by placing probes on locations

# 50 Hz RESIDENTIAL WIRING SCHEMATIC

## 230 Volt/50 Hz Residential Wiring Schematic with 2 Pole RCD Breaker Box

### 230 VAC House Breaker Box

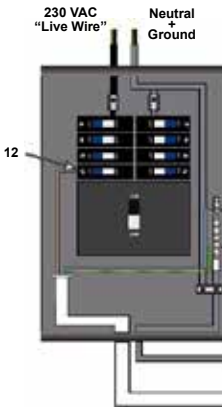

### RCD Breaker Box

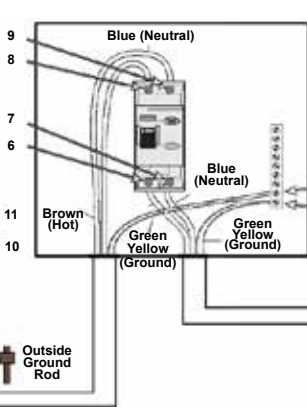

### Spa System Box

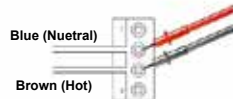
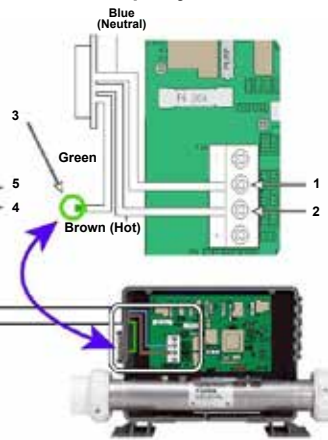

Test for Voltages by placing probes on these locations

# FREQUENCY DRIVE WIRING DIAGRAM (EP-16)

## FREQUENCY DRIVE WIRING DIAGRAM

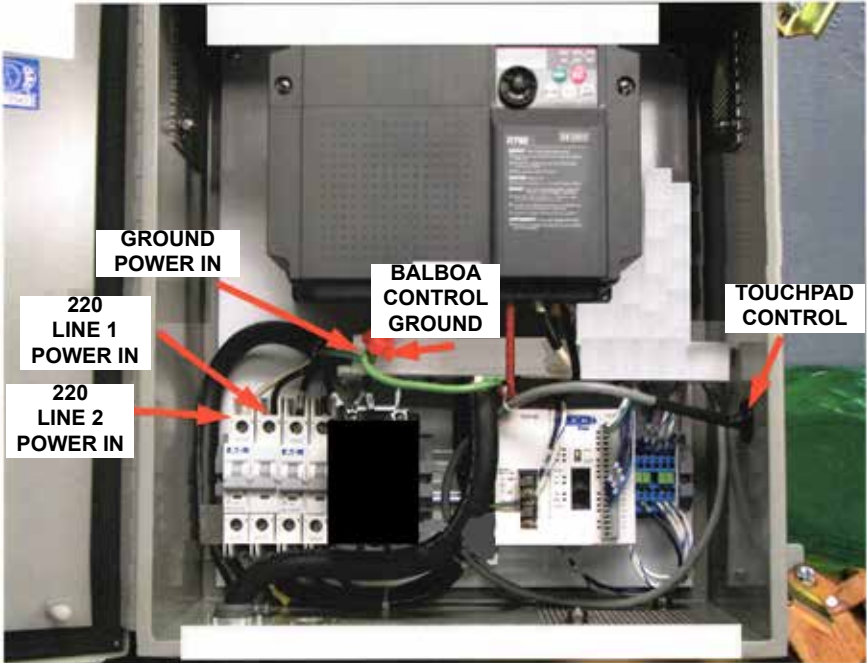

**NOTE: THE POWER IN TO THIS CONTROL DOES NOT HAVE A COMMON LINE IN, ONLY A GROUND. DO NOT HOOK A COMMON TO A POWER IN TERMINAL! THIS WILL DAMAGE THE UNIT**

**GREEN GROUND) CONNECT TO GROUNDING BAR**

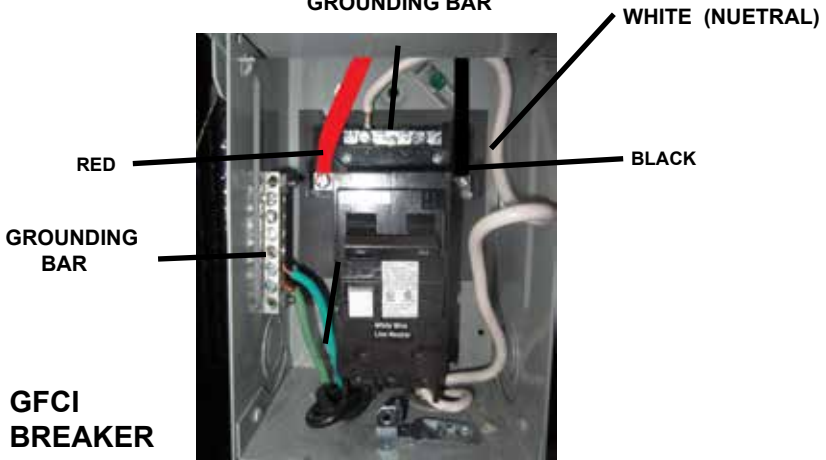

**IMPORTANT:** REQUIRED SIEMENS 60A GFCI CIRCUIT BREAKER TO OPERATE THE TIDALFIT EP-16



# TIDALFIT SPECIFICATIONS\*

## TIDALFIT (EP-12) ACTIVE/(EP-12)

### ACTIVE

Dimensions	144 x 91 x 45 in	366 x 231 x 114 cm
Volume	1300 gal	4921 lt
Weight (dry/filled)	1750 / 12592 lbs	794 / 5711 kg

### ACTIVEPLUS

Dimensions	144 x 91 x 52 in	366 x 231 x 132 cm
Volume	1500 gal	5678 lt
Weight (dry/filled)	2000 / 14510 lbs	907 / 6582 kg
**Heater	5.5 kW	3.0 kW
**Pumps/Circ. System	0.25 Hi-Flo Circ	0.25 Hi-Flo Circ
**Filtration	(1) Micro Filter (2) 50 sq ft	(1) Microfilter (2) 50 sq ft

## TIDALFIT (EP-14)

Dimensions	168 x 91 x 52 in	427 x 231 x 132 cm
Volume	1750 gal	6625 lt
Weight (dry/filled)	2000 / 16595 lbs	907 / 7527 kg
Heater	5.5 kW	3.0 kW
Pumps/Circ. System	0.25 Hi-Flo Circ 4.8 BHP 1-SP	0.25 Hi-Flo Circ 2.0 BHP 1-SP
Filtration	(2) Micro Filter	(2) Micro Filter
Cascade WF	Standard	Standard

## TIDALFIT (EP-15)

Dimensions	180 x 91 x 60 in	457 x 231 x 152 cm
Volume	1850 gal	7000 lt
Weight (dry/filled)	2225 / 17654 lbs	1009 / 8008 kg
Heater	5.5 kW	3.0 kW
Pumps/Circ. System	0.25 Hi-Flo Circ	0.25 Hi-Flo Circ
Filtration	(2) 75 sq ft	(2) 75 sq ft
Dual 9 in. WF	Standard	Standard

## TIDALFIT (EP-16)

Dimensions	192 x 91 x 60 in	487 x 231 x 152 cm
Volume	2200 gal	8328 lt
Weight (dry/filled)	3500 / 21848 lbs	1588 / 9910 kg
Heater	5.5 kW	3.0 kW
Pumps/Circ. System	0.25 Hi-Flo Circ	0.25 Hi-Flo Circ
Filtration	(2) 75 sq ft	(2) 75 sq ft
Cascade. WF	Standard	Standard

\* Information may be use as a reference only. Please verify before installation

\*\* Standard for all versions of EP-12

# TIDALFIT SEMI IN-GROUND EP-12/EP-14/ EP-15 ARCHITECTURAL SPECIFICATIONS

Dry Weight .....2000lbs.  
Filled Weight .....14510 lbs  
Dimensions.....144" x 91" x 52"  
Volume.....1300 Gallons

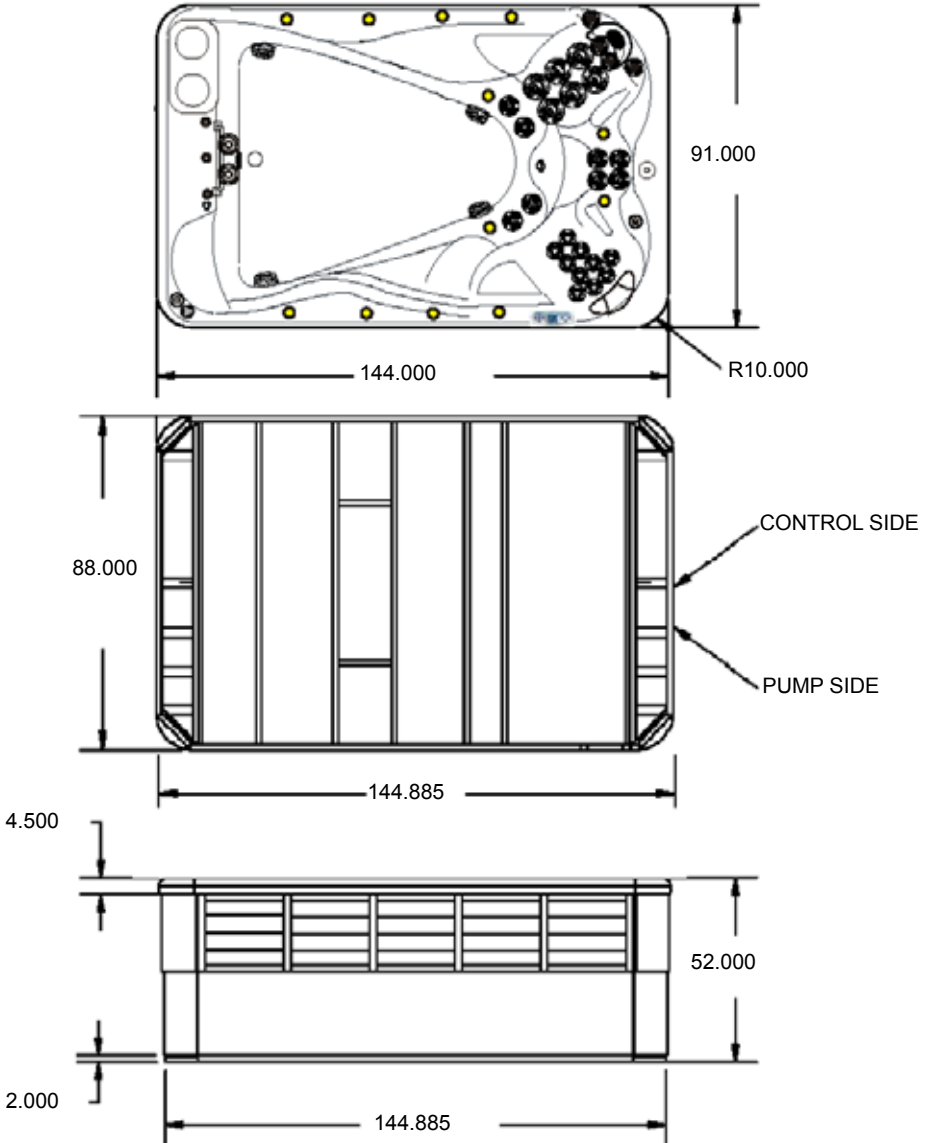

# TIDALFIT SEMI IN-GROUND EP-12/EP-14/ EP-15 ARCHITECTURAL SPECIFICATIONS

Dry Weight .....2000lbs.  
 Filled Weight .....16595 lbs  
 Dimensions.....168" x 91" x 52"  
 Volume.....1750 Gallons

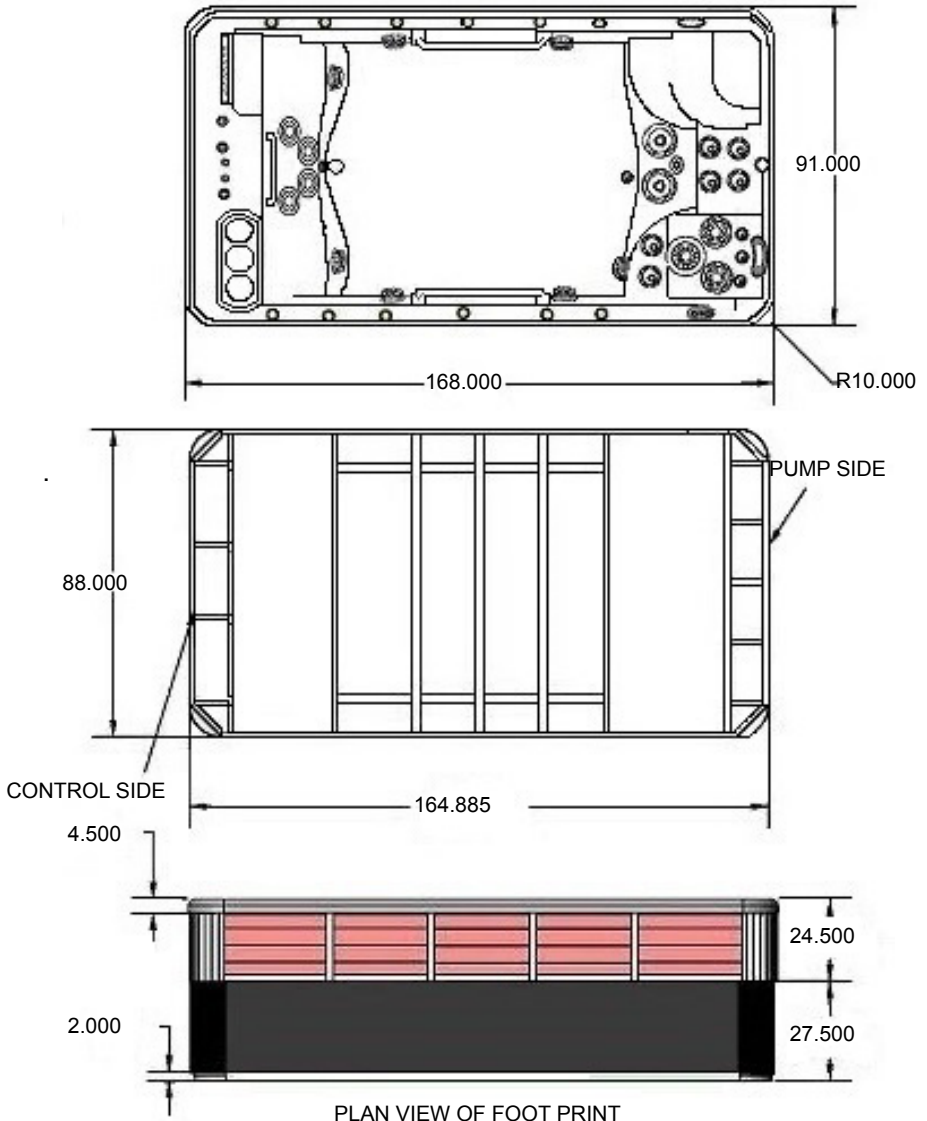

# TIDALFIT SEMI IN-GROUND EP-12/EP-14/EP-15 ARCHITECTURAL SPECIFICATIONS

Dry Weight .....2225lbs.  
 Filled Weight .....17654 lbs  
 Dimensions.....180" x 91" x 60"  
 Volume.....1850 Gallons

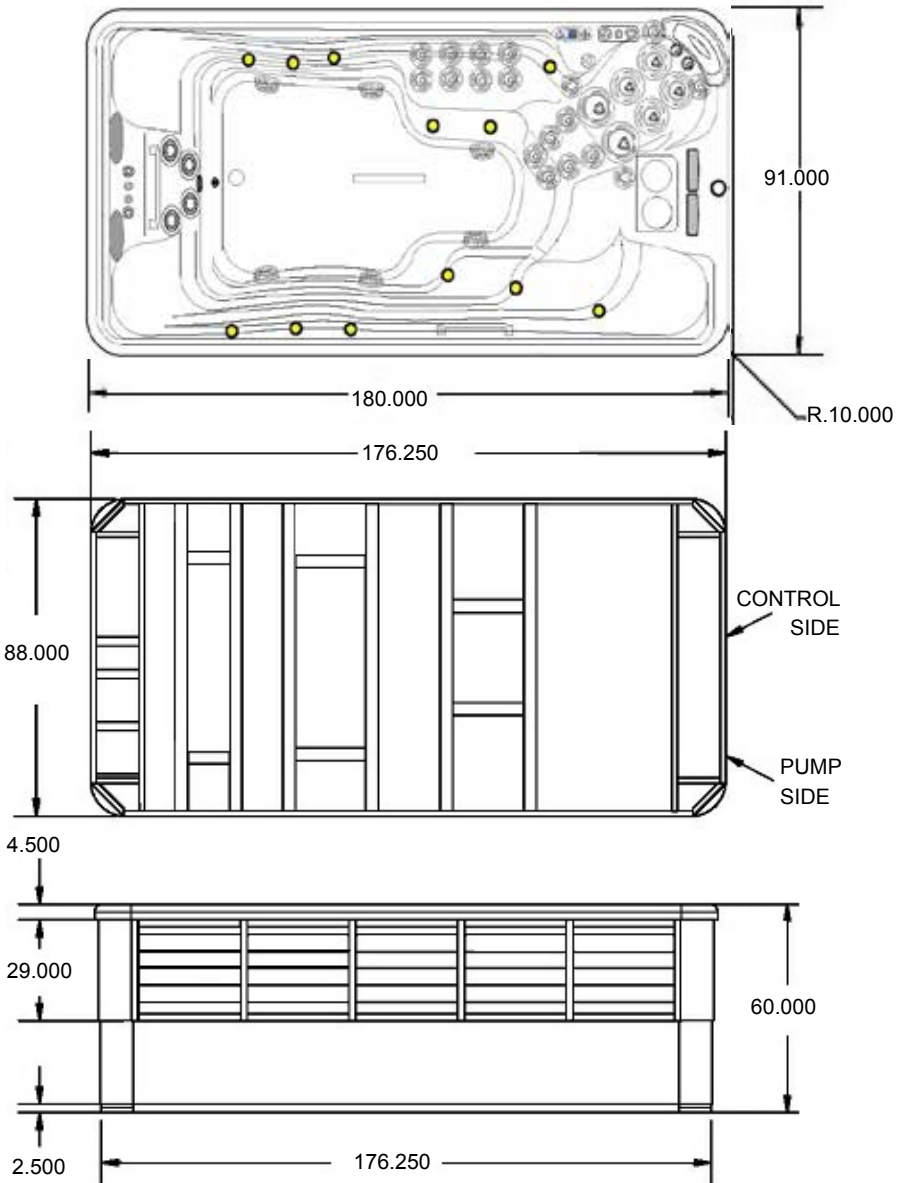

# TIDALFIT SEMI IN-GROUND INSTRUCTIONS

---



The depth of the dig will vary based upon the on the terrain or slope.



Crane the spa into position like a normal spa delivery.

# TIDALFIT SEMI IN-GROUND INSTRUCTIONS



Place 1 bag in each corner and 1 in the middle of each long side. This will allow you to remove the straps on the spa is in position. Allow the ice to melt and then the spa will be ready for back fill with gravel

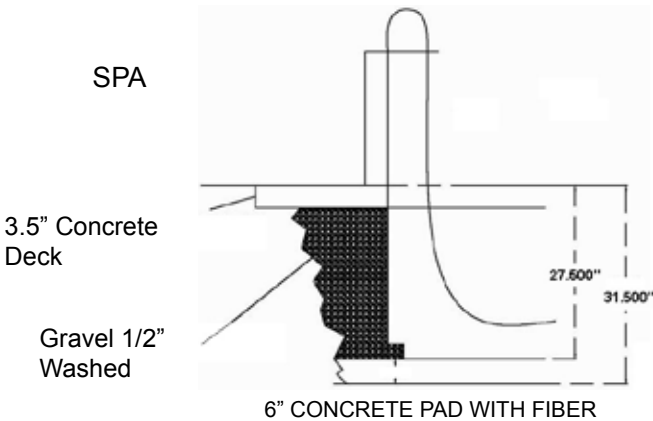

In a flat application: Use gravel NOT dirt. Using dirt you have to compact it, this will create unruly pressure on the spa. Gravel gives you about 98% compaction just by pouring it in the void (overdig). then you can pour your concrete decking. If a wooden deck is being built there is no real need to backfill except to keep the ground from around the spa from eroding.

# TIDALFIT START-UP

---

Please read each step of the Start-up section prior to doing the step.

## SELECTING A LOCATION

---

In preparation for installing your new TidalFit, you should ensure that your chosen location meets some minimum guidelines:

- 1) Place your TidalFit on a surface that is large enough for the entire TidalFit to fit. Consider the space needed to easily access equipment compartments and circuit breakers. Remember, all electronics must be kept dry.
- 2) The TidalFit must be on a solid, level foundation. Recommended: 6 inches of reinforced cement slab with wire mesh on compacted ground that has cured for at least 72 hours. Your warranty will be voided if the TidalFit is not properly installed. Structural damage due to an improper foundation is not covered under warranty.
- 3) To avoid potential water damage to the skirt and frame, your TidalFit should be placed on a site where it will not be in the way of water sprinklers.
- 4) **OUTDOOR POOL:** Consider building codes, electrical and plumbing codes, desired proximity to house, wind and sun exposure, location of trees (falling leaves, shade), dressing area, landscaping and lighting when selecting a location.
- 5) **INDOOR POOL:** Floor surface must have traction to prevent slipping when wet. A floor drain is optimum. As room humidity will increase because of the spa, provide ample ventilation to prevent dry rot, mildew and mold. Use materials that will withstand humidity. There may be a need for cross-ventilation fans and/or dehumidifiers. The spa chemicals may corrode some household metals. Provide ample room if servicing should be needed. Strong foundational support is vital, particularly if a second-story site is selected.
- 6) Ensure the equipment compartment is in a location where it will not be damaged by water drainage. Cover the equipment compartment with a heavy screen if rodents are a problem. Damage due to rodents is not covered under warranty.
- 7) Have the pool deck installed by a knowledgeable contractor to ensure proper support.

# TIDALFIT START-UP

---

## INSPECTION

---

You will want to inspect your TidalFit, prior to filling it up with water. Look for and remove any debris in the pool tub and in the filter. Verify that pump plugs are installed on the pumps and the pump unions are tight.

## FILLING THE TIDALFIT WITH WATER

---

**NOTE: Do Not fill your TidalFit with hot water straight out of your water heater or tap. This water may be as hot as 180°F and will cause damage to the surface and plumbing of the pool. This will void your warranty. Level the pool before filling.**

- 1) Prepare to fill the tub by removing all debris.
- 2) Remove the filters from your pool (see Removing, Installing and Cleaning Filters, page 51.)
- 3) Place your garden hose in the center of the filter .
- 4) Fill the tub from the circulation pump line until water level is above the foot-well.

**NOTE: This will purge all the air out of the circulation pump. An air lock can cause damage to the circulation pump and is not covered under warranty.**

- 5) Once the water level is filled over the foot-well, you can pull the hose out of the filter line and continue filling the pool from the filter well.
- 6) Fill the pool to the bottom of the pillows.

**NOTE: Do Not Overfill Your Pool.**

- 7) With the front panel off, verify there are no leaks at the pump union.

**NOTE: Pump unions can become loose during shipping. Verify that there are no leaks during filling of the pool.**

- 8) Reinstall the circulation pump screen and all filters.

## TURNING THE POWER ON

---

Turn the power to the pool on at the main circuit breaker. Verify that your pool has no error codes. Verify that there is good water circulation in the pool. The pumps will come on in cycles, for 1 minute each cycle.



# TIDALFIT START-UP

---

## VERIFYING WATER CIRCULATION

---

- 1) Open all the jets.
- 2) Press the Pump 1 key to turn the pumps on or off.
- 3) Make sure each seat has water flow. Note: On certain pools there is a diverter valve. Verify where the diverter valve is located.

## TESTING THE GFCI BREAKER

---

**NOTE:** The electrical service panel for your pool should be equipped with a GFCI breaker. To avoid the risk of electrical shock, perform the following safety test before each use of your pool.

- 1) Make sure the power is turned on at the electrical service panel.
- 2) Turn on the GFCI breaker. If the breaker stays on, it is functioning properly.

**NOTE:** The spa system will automatically trip the GFCI 24 hours after power up. This is a safety feature and can not be disabled.

## DANGER: RISK OF ELECTRICAL SHOCK

If the GFCI breaker fails to operate as described, there is a possibility of an electrical shock if the TidalFit is used. Shut off the power at the main electrical service panel until the source of the problem has been identified and corrected by a licensed electrician or qualified pool technician.

**NOTE:** When power is turned on, your pool is automatically programmed to start circulating water through the circulation pump. Each pump and blower will come on consecutively for approximately 1 minute to automatically purge the system. Adjust your temperature by pressing the up button on your touch pad until the desired temperature is displayed. This setting will allow your pool to heat to the set temperature.

**CAUTION:** *If water is not noticeably coming from your pool jets during the automatic purge, turn on the high speed pump. If water is still not coming from the jets, the pump needs to be manually primed, following the steps below.*

# TIDALFIT START-UP

---

## PRIMING THE PUMP

---

- 1) Turn off power at electrical service panel.
- 2) Locate and loosen one of the pump plugs on each pump by turning it counterclockwise one half of one turn.
- 3) Allow air to escape from fittings. When a steady stream of water flows from the pump plug, close it by turning it clockwise until tight.
- 4) Turn on power at electrical service panel.
- 5) Check once more to make sure that water is flowing from the jets during auto purge. If so, continue. If no water is coming from your spa jets, please call your Artesian dealer for further assistance.

## WATER PREPARATION

---

**NOTE: Before putting your new pool into operation, understand that preparing your new water is an important part of maintenance. Failure to properly prepare your water can result in substantially decreasing the life of the components and may void your warranty in severe cases. Your Artesian dealer should have a start-up and maintenance kit available for you when you receive your pool.**

# TOPSIDE CONTROL INSTRUCTIONS (EP-15)



## THE MAIN SCREEN

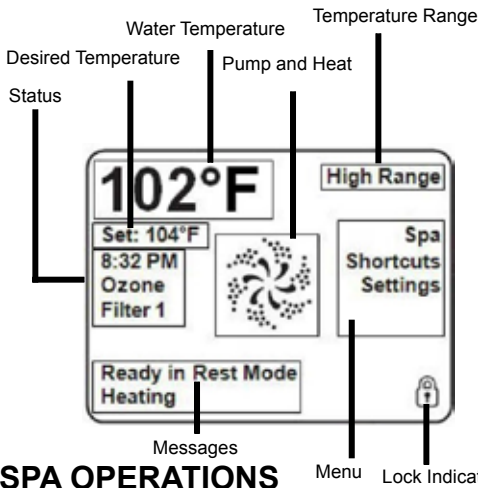

Important information about spa operation can be seen quickly from the Main Screen.

The actual water temperature can be seen in large text and the desired water temperature is shown in smaller text.

The time-of-day, ozone/uv, filter operation, messages, heat range, menu option and panel lock are also displayed on the main screen.

## SPA OPERATIONS

There are three ways to operate the spa functions from the topside. You can turn the spa pumps and lights from the topside through the buttons on the left hand side of the control panel, or you can use the spa menu using the navigation buttons or you can use the short cut setting.



**Jet 1** Jets 1 Button: The jets 1 button will operate pump number 1. First press of the Jets 1 button will activate pump 1. A second press of the Jets 1 button will deactivate pump 1. If pump 1 is not manually turned off by pressing the Jets 1 button, pump will automatically timeout after 15 minutes.

# TOPSIDE CONTROL INSTRUCTIONS

---



**Jets 2 Button:** The jets 2 button will operate pump number 2. First press of the Jets 2 button will activate pump 2. A second press of the Jets 2 button will deactivate pump 2. If pump 2 is not manually turned off by pressing the Jets 2 button, pump will automatically timeout after 15 minutes.



**Jets 3 Button:** (If your TidalFit is equipped with a third pump.) The jets 3 button will operate pump number 3. First press of the Jets 3 button will activate pump 3. A second press of the Jets 3 button will deactivate pump 3. If pump 3 is not manually turned off by pressing the Jets 3 button, pump will automatically timeout after 15 minutes.



**Light Button:** The light button operates the L.E.D. Lights. First Press of the light button will turn on the lights. A second press of the light button will turn the lights off. The TidalFit lighting systems have different modes. To cycle through the different modes you must turn the light on and off, once the desired mode is selected, leave the light on. If the light is not manually turned off it will automatically timeout after 240 minutes.

Use the navigation buttons to highlight the operation you would like to perform.



Once the operation is highlighted press the Select Button,

to engage the highlighted item.



**Back button:** Will return you to the main menu.





Use the Right Arrow Button and highlight SPA in the menu.

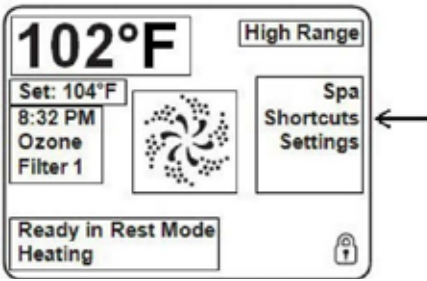

Use the Down Arrow Button and highlight Short cuts in the menu.

# TOPSIDE CONTROL INSTRUCTIONS



Press the Select Button  when the Shortcut option is highlighted.

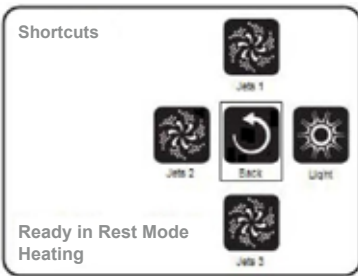

The main screen will change to shortcut operation screen.

The shortcut menu assigns the operation to the navigation buttons.



**Up Button:** The UP button will operate pump 1. First press of the UP button will activate pump 1. A second press of the UP button will deactivate pump 1. If pump 1 is not manually turned off by pressing the UP button it will automatically timeout after 15 minutes.



**Left Button:** The Left button will operate pump 2. First press of the Left button will activate pump 2. A second press of the Left button will deactivate pump 2. If pump 2 is not manually turned off by pressing the UP button it will automatically timeout after 15 minutes.



**Right Button:** The RIGHT button operates the L.E.D. Lights. First Press of the RIGHT button will turn on the lights. A second press of the Right button will turn the lights off. The Island Spas lighting systems have different modes. To cycle through the different modes you must turn the light on and off, once the desired mode is selected, leave the light on. If the light is not manually turned off it will automatically timeout after 240 minutes.

# TOPSIDE CONTROL INSTRUCTIONS

---



**Down Button:** The Down button will operate pump 3 (if applicable). First press of the Down button will activate pump 3. A second press of the Down button will deactivate pump 3. If pump 3 is not manually turned off by pressing the Down button it will automatically timeout after 15 minutes.



**Select Button:** Will return operation back to the main menu.

## TEMPERATURE OPERATION

---

The only item that can be changed on the left side of the Main Screen is the Set Temperature.



**Left Button:** Press the left arrow button to highlight the set temperature.

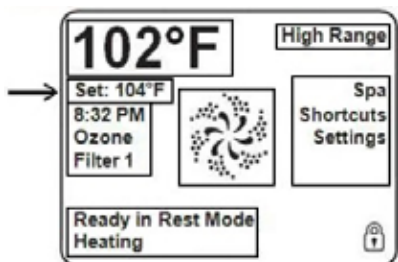

**Up Button:** Use the Up Button to raise the set temperature



**Down Button:** Use the Down Button to lower the set temperature.



**Select Button:** Press the Select Button to save the Set Temperature Range: The Temperature Range is displayed in the upper Right Hand corner of the display. This indicates what the range of the set point can be. Please see the section on adjusting setting to change the Temperature Range

# TOPSIDE CONTROL INSTRUCTIONS

---

High Range: Set point can be set between 80°F and 104°F

Low Range: Set Point can be set between 50°F and 99°F

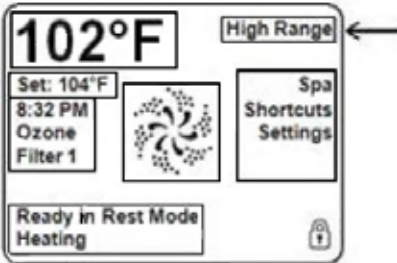

## THE SETTINGS SCREEN

---

The Settings Screen is where all programming and other spa behaviors are controlled. This screen is where all programming and other spa behaviors are controlled.



Right Button: Press the Right button to go to the Menu section.



Down Button: Press the Down Button until Settings is highlighted; you will need to press it twice.



Select Button: Press the Select Button to enter the Settings Screen.

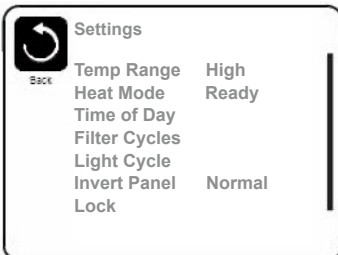

# TOPSIDE CONTROL INSTRUCTIONS

---

## TEMP RANGE

---

The first setting available to change is Temp Range. This system incorporates two temperature range settings. The specific range that is selected (High or Low) will be displayed in the upper right hand corner of the main screen.

High range can be set between 80°F and 104°F.

Low range can be set between 50°F and 99°F.



Select Button: When the temp range is highlighted in the Setting Menu pressing the Select Button will change from High to Low or Low to High.



Left Button: Press the left button to highlight the Back Icon.



Select Button: Press the select button to return to the main Menu

OR



Down Button: Press the down button to go to Heat Mode.

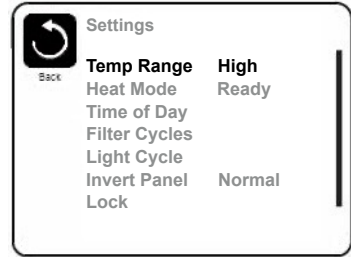

## HEAT MODE

---

Heat Mode indicates if the spa is Ready mode or Rest Mode. The heat mode will be displayed in the bottom right screen of the main screen display.

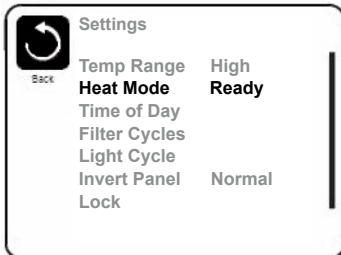



# TOPSIDE CONTROL INSTRUCTIONS

---

## READY MODE

---

In ready mode the heater will maintain the set temperature. If your Tidal-Fit spa is not programmed for 24 hours Filter it will turn on the circulation pump every half an hour to test the water temperature. If the water temperature is one degree below the set point the circulation pump will continue to run to bring the water temperature to the set point temperature.

If the water temperature is at the set point temperature the circulation pump will turn off after 5 minutes. If your filtration cycle is set for 24 hours, the circulation pump will continue to run.

## REST MODE

---

Will only allow the spa to heat during a filtration cycle, if the spa is not in a filtration cycle, you can press the pump 1 button to activate the heater. The spa will go into Ready mode for 1 hour and then go back to rest mode.



Select Button: When the heat mode is highlighted in the Settings Menu pressing the Select Button will change from Ready to Rest or Rest to Ready.



Left Button: Press the left button to highlight the Back Icon.



Select Button: Press the select button to return to the main Menu.

OR



Down Button: Press the down button to go to Time of Day.

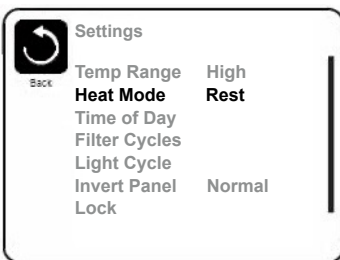

# TOPSIDE CONTROL INSTRUCTIONS

---

## TIME OF DAY

---

When the time of day is highlighted.



Right Button: Press the Right button to go to the Time of Day Menu.

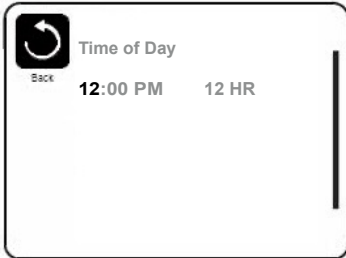

The screen will change to Time of Day Settings.



Right Button: Press the Right button to Highlight the hours.



Up Button: To increase the hours.



Down Button: To decrease the hours

**NOTE: To change from AM to PM you will need to adjust the hours past 12.**



Right Button: Press the Right button to highlight the minutes.



Up Button: To increase the minutes.



Down Button: To decrease the minutes.



Right Button: Press the Right button to highlight the time format.

12HR: 12 hour format will be displayed.

24HR: 24 hour format will be displayed.



Up Button: To change the time format.

# TOPSIDE CONTROL INSTRUCTIONS

---



Down Button: To change the time format.



Left Button: Press the left button to high light. Save Icon (you will need to press it three times to high light the save button.)



Save



Select Button: Press the select Icon to save and return to the main Menu.

**OR**



Down Button: Press the down button to highlight Cancel Icon.



Cancel



Select Button: Press the select button to cancel changes and return to the main Menu.

Select the Setting menu.



Down Button: Press the down button to go to Filter Cycle.

## SETTING FILTER CYCLE

---

When the Filter Cycle is highlighted:



Right Button: Press the Right button to go to the Filter Cycle Menu.

The Screen will change to Filter Cycle menu.

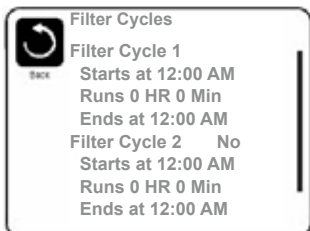

# TOPSIDE CONTROL INSTRUCTIONS

---



Right Button: Press the Right button to highlight Filter Cycle 1 Start time Hour.



Up Button: To Increase the Filter Cycle 1 Start time hours.



Down Button: To decrease the Filter Cycle 1 Start time hours.  
**(NOTE: To change AM and PM you will need to cycle the hours past 12)**



Right Button: Press the Right button to high light Filter Cycle 1 Start time minutes.  
**(NOTE: Changing the minutes goes by 15 minute intervals)**



Up Button: To increase the Filter Cycle 1 Start time Minutes.



Down Button: To decrease the Filter Cycle 1 Start time Minutes.



Right Button: To highlight the Run Time Hours.



Up Button: To increase the Run Time Hours.



Down Button: To decrease the Run Time Hours.



Right Button: Press the Right button to high light Run Time Minutes.  
**(NOTE: Changing the minutes goes by 15 minute intervals)**



Up Button: To increase the Run Time Minutes.



Down Button: To decrease the Run Time Minutes.  
The panel calculates the end time and displays it automatically.



Right Button: Press the Right button to highlight Filter Cycle 2.

# TOPSIDE CONTROL INSTRUCTIONS

---



Up Button: To Filter Cycle 2 on or off.

OR



Down Button: To Filter Cycle 2 on or off.



Right Button: Press the Right button to high light Filter Cycle 1 Start time Hour.



Up Button: To Increase the Filter Cycle 2 Start time hours.  
**(NOTE: To change AM and PM you will need to cycle the hours past 12)**



Down Button: To decrease the Filter Cycle 2 Start time hours.  
**(NOTE: To change AM and PM you will need to cycle the hours past 12)**



Right Button: Press the Right button to high light Filter Cycle 2 Start time minutes.  
**(NOTE: Changing the minutes goes by 15 minute intervals)**



Up Button: To increase the Filter Cycle 2 Start time Minutes.



Down Button: To decrease the Filter Cycle 2 Start time Minutes.



Right Button: To highlight the Run Time Hours.



Up Button: To increase the Run Time Hours.



Down Button: To decrease the Run Time Hours.



Right Button: Press the Right button to high light Run Time Minutes.  
**(NOTE: Changing the minutes goes by 15 minute intervals)**



Up Button: To increase the Run Time Minutes.

# TOPSIDE CONTROL INSTRUCTIONS

---



Down Button: To decrease the Run Time Minutes.

The panel calculates the end time and displays it automatically. In order to maintain sanitary conditions, as well as protect against freezing, the system will purge water from their respective plumbing by briefly running the pumps at the beginning of each filter cycle. If Filter Cycle is set to off, or filter cycle 1 is set to 24 hours. The second purge cycle will start at the time that is set for filtration cycle 2 start time.



Right Button: Press the Right button to highlight  Save 1 Icon.



Select Button: Press the select button to save and return to the Setting Menu

OR



Down Button: Press the down button to highlight the  Cancel Icon.

Select the Setting menu.



Down Button: Press the down button until Invert display is highlighted.

## INVERT DISPLAY

---



Select Button: Press the select button to Change the display from Normal to Inverted.

Normal: Display will be towards the inside of the spa.

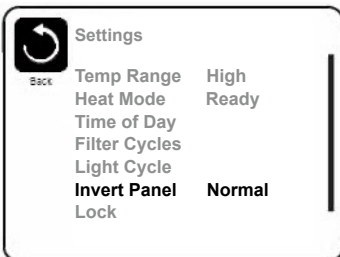

# TOPSIDE CONTROL INSTRUCTIONS

---

Inverted: Display will be towards the outside of the spa.

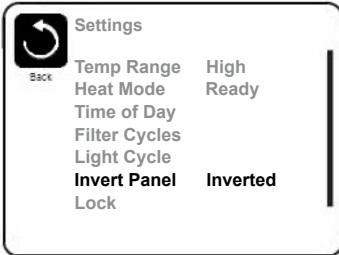

When the display is inverted, the navigation buttons will also be inverted to work with the display.



Down Button: Press the down button until Lock is highlighted.

## RESTRICTING OPERATIONS (LOCK)

---

The controller can be restricted to prevent unwanted use or changes. There are two lock options.

Settings: Will lock out anyone from changing the Set Temperature and other programming features all jet operations will work.

Panels: Prevent the topside from being used.



Select Button: Press the select button to enter the lock menu. The screen will change to Lock Menu.

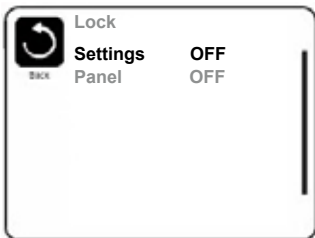

Right Button: Press the Right button to highlight Settings OFF/ON.



Select Button: Press the select button to turn Setting lock on.

# TOPSIDE CONTROL INSTRUCTIONS

---



Down Button: Press the down button until Panel is highlighted.



Select Button: Press the Select button to turn Panel lock on.

The screen will change and go back to the main display.

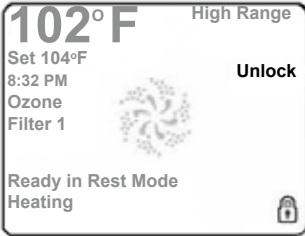

To unlock the system:



Right Button: Press the Right button to highlight Settings OFF/ON.

Then press the following buttons:



Select Button



Select Button



Down Button

Follow the above steps to unlock the panel.



Left Button: Press the left button to highlight



Back Icon.



Select button: Press the select button to go back to the setting menu.



Down Button: Press the down button until Hold is highlighted.



# TOPSIDE CONTROL INSTRUCTIONS

---

## HOLD

---

Hold mode is used to disable the pump during service functions, cleaning or replacing the filters. The hold will last for 1 hour unless the mode is exited manually.



Select button: Press the select button to go back to activate the hold mode.



Left Button: Press the left button to highlight  Back Icon.



Select Button: Press the select button to activate the hold mode.



Down Button: Press the Down Button until Utilities is highlighted.

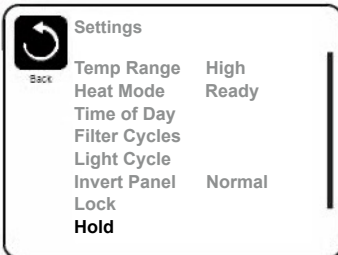

## UTILITIES

---

The Utilities menu is used for trouble shooting and for technicians. As this is for service personnel we will just explain what each subject is. We do not recommend changing anything unless walked through the setting with a technician.

A/B Temps:

This will display the temperature on sensor A and B on the main display.

Fault Log:

This is a log of the last 24 actions on the spa. It is not necessary errors.

GFCI Test: This will cause the GFCI to trip to verify that is working correctly.



Down Button: Press the down button to go to the Preference Menu.

# TOPSIDE CONTROL INSTRUCTIONS

## PREFERENCE

The screen will change to the Preferences Menu.

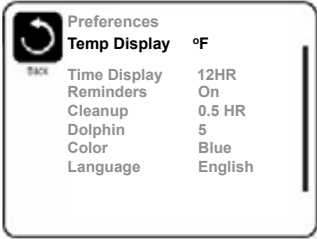

## TIME DISPLAY



Right button: Press the right button to highlight temp Display.



Select button: Press the select button to change from F° (Fahrenheit) to C° (Celsius) or from C° (Celsius) to F° (Fahrenheit).



Down Button: Press the Down Button until Time Display is highlighted.



Select Button: Press the select button to change from 12HR to 24HR or 24HR to 12HR time display.

**NOTE: The Reminders are messages that will appear in the bottom left hand corner of the main display, they are maintenance reminders for clean filter, check PH etc.**

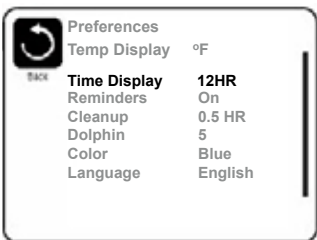

# TOPSIDE CONTROL INSTRUCTIONS

---

## DOLPHIN (NOT USED)

---



Down Button: Press the Down Button until Dolphin is highlighted. This option is not available.

## COLOR

---



Down Button: Press the Down Button until Color is Highlighted.



Select Button: Press the select button to change the background color on the display. Color options are: Blue, Red, Purple, Grey and Green.

## LANGUAGE

---

This will change the language displayed on the screen to the language you choose.



Down Button: Press the Down Button until Language is highlighted.



Select Button: Press the select button to open the Language Menu.



Down Button: Press the Down Button until the Language you desire is highlighted. Language options are; English, French, Spanish and German.



Select Button: Press the select button to choose highlighted language



Left Button: Press the left button to highlight



Back Icon



Select Button: Press the select button to go back to the setting menu.



Down Button: Press the Down Button until the Information is highlighted. Used for Technical and service personnel.

# TOPSIDE CONTROL INSTRUCTIONS

---

## HEATER-RELATED MESSAGES

---

During the warmer month it is recommended to change the filter cycle duration to keep the spa from overheating with the high ambient temperature.

### **The water flow is low – M016**

There may not be enough water flow through the heater to carry the heat away from the heating elements. Heater start up will begin again after about 1 minute.

### **Flow-Related Checks**

Check for low water level, suction flow restriction (filters) closed valves or trapped air.

### **The water flow has failed\* – M017**

There is not enough water flow through the heater to carry the heat away from the heating element and the heater has been disabled. After the flow problem has been resolved you must press any button to reset and begin the heater start up.

### **Flow-Related Checks**

Check for low water level, suction flow restriction (filters) closed valved, or trapped air.

### **The heater may be dry\* – M028**

Possible dry heater or not enough water in the heater to start it. The spa is shut down for 15 minutes. Press any button to reset the heater start-up.

### **Flow-Related Checks**

Check for low water level, suction flow restriction (filters) closed valved, or trapped air.

### **The heater is dry\* – M027**

There is not enough water in the heater to start it. The spa is shut down. After the problem has been resolved, you must clear the message to re-start the heater.

# TOPSIDE CONTROL INSTRUCTIONS

---

## SENSOR-RELATED/MISC. MESSAGES

---

### **Flow-Related Checks**

Check for low water level, suction flow restriction (filters) closed valve or trapped air.

### **The heater is too hot\* – M030**

One of the water temperature has detected 118°F (47.8°C) in the heater and the spa is shut down. You must clear the message when water is below 108°F (42.2°C).

### **Flow-Related Checks**

Check for low water level, suction flow restriction (filters) closed valve or trapped air.

## SENSOR RELATED MESSAGES

---

### **Sensors are out of sync – M015**

The temperature sensors may be out of sync. Call you dealer for service.

### **Sensors are out of sync -- Call for service – M026**

The temperature sensors are out of sync. Call you dealer for service.

### **Sensor A Fault, Senor B Fault – Sensor A: M031, Sensor B: M032**

The temperature sensors or sensor circuit has failed. Call you dealer for service

## MISCELLANEOUS MESSAGES

---

### **Communications error**

The control panel is not receiving communication from the system. Call your dealer for service.

### **Test software installed**

The Control System is operating with test software. Call your dealer for service.

### **°F or °C is replaced by °T**

The Control System is in Test Mode. Call your dealer for service.

# TOPSIDE CONTROL INSTRUCTIONS

---

## SYSTEM RELATED MESSAGES

---

### **Program memory failure – M022**

Call you dealer for service.

### **The settings have been reset– M021**

Call you dealer for service if this message appears on more than one power-up.

### **The clock has failed –M020**

Call you dealer for service.

### **Configuration error (Spa will not Start Up)**

Call you dealer for service.

**The GFCI test failed (System Could Not Test the GFCI) – M036** (North America Only) May indicate an unsafe installation. Call you dealer for service.

### **A pump may be stuck on – M034**

Water may be overheated.

### **NOTE: POWER DOWN THE SPA! DO NOT ENTER THE WATER!**

Call you dealer for service.

### **Hot fault – M035**

A pump appears to have been stuck on with the spa was last powered on. Water may be overheated.

### **NOTE: POWER DOWN THE SPA! DO NOT ENTER THE WATER!**

Call you dealer for service.

# TOPSIDE CONTROL INSTRUCTIONS

---

## REMINDER MESSAGES

---

### **Check the pH**

May appear on a regular schedule, i.e. every 7 days. Check pH with a test kit and adjust pH with the appropriate chemicals.

### **Check the sanitizer**

May appear on a regular schedule, i.e. every 7 days. Check sanitizer level and other water chemistry with a test kit and adjust with the appropriate chemicals.

### **Clean the filter**

May appear on a regular schedule, i.e. every 30 days. Clean the filter media as instructed by the manufacturer.

### **Test the GFCI (or RCD)**

May appear on a regular schedule, i.e. every 30 days. The GFCI or RCD is an important safety device and must be tested on a regular basis to verify its reliability. Every user should be trained to safely test the GFCI or RCD associated with the hot tub installation.

### **Change the water**

May appear on a regular schedule, i.e. every 90 days. Change the water in the spa on regular basis to maintain proper chemical balance and sanitary conditions.

### **Clean the cover**

May appear on a regular schedule, i.e. every 180 days. Vinyl covers should be cleaned and conditioned for maximum life.

### **Change the filter**

May appear on a regular schedule, i.e. every 365 days. Filters should be replaced occasionally to maintain proper spa function and sanitary condition.

# SWIMSPEED CONTROL INSTRUCTIONS (EP-16)

---



1. Adjust Up or Down as needed for preference
2. Turn Power On

## MAINTENANCE

---

Perform maintenance every 9-12 months.

1. Disconnect power
2. Take panel away
3. Drain water down to benches (Top level) \_\_\_\_\_
4. Visually check Hydro hoses for cracks in connections and for leaks. If any are present call DEALER.
5. Visually check Hydro Fluid Level -Make sure glycol is at proper level (FULL in sight glass)
6. Add fresh water
7. If temp reading is below 100°C call DEALER (Bottom level) \_\_\_\_\_
8. Reconnect power



## WARNING

This system must be wired by a certified electrician.  
Wiring diagrams are located inside the control box to aid in the installation.



**CAUTION:** Hydraulic Lines are under pressure.

## REQUIRED VOLTAGE FOR CONTROL BOX

---

A 40A/220 volt single phase service is required to operate. This service should be connected by a certified electrician to the control box according to the enclosed wiring diagram. The control is a (VFD) Variable Frequency Drive which converts 220 volt single phase input power to 220 volt three phase output power to drive the Hydraulic Water Current Motor.

## HYDRAULIC WATER CURRENT MOTOR

---

The hydraulic water current motor input power is 220 volt three (3) phase This motor must be wired as shown in the enclosed diagram failure to do so will result in PERMANENT damage to the electric motor and void all warranties.



# DIAGNOSTIC MESSAGES

---

No message on display.

**Power has been cut off to the spa.**

- The control panel will be disabled until power returns. Time of day will be preserved for 30 days with a battery back-up on EL8000 and EL 5000 systems. EL1000 and some EL2000 systems reset the time of day on each power-up. Pool settings are preserved on all systems

OHH

**“Overheat” - The pool has shutdown. On some systems, an alarm may sound. One of the sensors has detected 118°F (approximately 47.8°C) at the heater.**

- **DO NOT ENTER THE WATER.** Remove the spa cover and allow water to cool. Once the heater has cooled, reset by pushing any button. If pool does not reset, shut off the power to the pool and call your dealer or service organization

OH5

**“Overheat” - The pool has shutdown. One of the sensors has detected that the pool water is 110°F (approximately 43.3°C).**

- **DO NOT ENTER THE WATER.** Remove the pool cover and allow water to cool. At 107°F (approximately 41.7°C), the pool should automatically reset. If pool does not reset, shut off the power to the pool and call your dealer or service organization

ICE

**“Ice” - Potential freeze condition detected.**

- No action required. The pumps and the blower will automatically activate regardless of pool status.

SnA

**Pool is shutdown. The sensor that is plugged into the Sensor “A” jack is not working**

- If the problem persists, contact your dealer or service organization. (May appear temporarily in an overheat situation and disappear when the heater cools).

SnB

**Pool is shutdown. The sensor that is plugged into the Sensor “B” jack is not working**

- If the problem persists, contact your dealer or service organization. (May appear temporarily in an overheat situation and disappear when the heater cools).

# DIAGNOSTIC MESSAGES

---

Sns

**Sensors are out of balance. If this is alternating with the temperature, it may just be a temporary condition. If the display shows only this message (periodically blinking), the pool is shut down.**

- If the problem persists, contact your dealer or service organization.

HFL

**A substantial difference between the temperatures sensors was detected. This could indicate a flow problem.**

- Check water level in pool. Refill if necessary. If the water level is okay, make sure the pumps have been primed. Press any button to reset.

LF

**Persistent low flow problems. (Displays on the fifth occurrence of the “HFL” message within 24 hours.) Heater is shutdown, but other spa functions continue to run normally.**

- Follow action required for “HFL” message. Heating capacity of the pool will not reset automatically, you may press any button to reset.

dr

**Inadequate water detected in heater.**

- Check water level in pool. Refill if necessary. If the water level is okay, make sure the pumps have been primed. Press any button to reset.

dr4

**Inadequate water detected in heater, (Displays on third occurrence of “dr” message.) Pool is shutdown.**

- Follow action required for “dr” message. Pool will not automatically reset; you may press any button to reset.

Pr

**When your pool is first actuated, it will go into Priming Mode.**

- See the M-7 Installation Instruction Manual for complete instructions on Power-up and Pump Priming. The Priming mode will last for up to 4 minutes and then the pool will begin to heat and maintain the water temperature in the Standard mode..

# DIAGNOSTIC MESSAGES

---

--F  
or  
--E

## Temperature unknown.

- After the pump has been running for 1 minute, the temperature will be displayed.

--E  
---

## Temperature not current in Economy or Sleep mode.

- In Economy or Sleep mode, the pump may be off for hours outside a filter. If you wish to see the current pool temperature, either switch to Standard mode or turn Jets1 on for at least a minute.

Sby

## Standby mode has been activated by pressing a button combination on the user panel.

- Press any button, except “Jets 1” to leave Standby Mode and return to normal operation.

pHL

## pH is low.

- Add pH increaser according to manufacturer's instructions.

pHH

## pH is high.

- Add pH reducer according to manufacturer's instructions.

SAL

## Sanitizer is low.

- Add sanitizer according to manufacturer's instructions.

SAH

## Sanitizer is high.

- Remove pool cover and allow sanitizer to dissipate.

drn

## The pump is on during Standby Mode to assist in draining the pool.

- Press “Jets 1” to turn off the pump when water has drained (or power off the pool.).

rE

## Hardware failure.

- Contact your dealer or service organization.

# DIAGNOSTIC MESSAGES

---

P5L

## Hardware failure.

- Contact your dealer or service organization if message appears on more than one power up.

C7C

## Firmware install problem.

- Contact your dealer or service organization if message appears on more than one power up.

C7E

## Configuration error. Pool cannot start up

- Contact your dealer or service organization.

9F1

## Pool could not trip GFCI.

- Contact your dealer or service organization . Continued operation may be unsafe.

5LU

## A pump appears to be stuck on, causing the water temperature to creep up, possibly to hazardous levels.

- **POWER DOWN POOL IMMEDIATELY. DO NOT ENTER THE WATER.** contact your dealer or service organization.

H0L

## A pump appears to have been stuck on the last time spa was powered.

- **POWER DOWN POOL IMMEDIATELY. DO NOT ENTER THE WATER.** Contact your dealer or service organization.

(Press the “Mode” button to reset a displayed reminder.\*)

# PERIODIC REMINDER MESSAGES

---

rPH

**Every 7 days.**

- Test and adjust pH chemical levels per manufacturer's instructions.

rSA

**Every 7 days.**

- Test and adjust sanitizer chemical levels per manufacturer's instructions.

rCL

**Every 30 days**

- Remove, clean, and reinstall filter per manufacturer's instructions.

•

rTG

**Every 30 days**

- Test and reset GFCI per manufacturer's instructions.

•

rDR

**Every 90 days**

- Drain and refill pool per manufacturer's instructions.

rCO

**Every 180 days**

- Clean and condition cover per manufacturer's instructions.

•

rTR

**Every 180 days**

- Clean and condition wood per manufacturer's instructions

rCH

**Every 365 days.**

- Install new filter.

rCA

**As needed.**

- Install new Mineral cartridge

\* User can suppress all reminders in User Preferences.

\*\*All of these Periodic Messages can be disabled individually by the pool manufacturer.

\*\*\*Any of these frequencies may be changed by the pool manufacturer.

# ROWING EXERCISE

- 1** Install Rowers  
Press the quick release button.  
Snap the back of the rowing bar into the mount.
- 2** Install First Set of Tension Cords  
Use the mounting loops as a slip knots around each safety bar.  
Clip tension cord to mounting loop.  
Clip tension cord to rowing bar.
- 3** Install Second Set of Tension Cords  
Choose a desired pair of the varying length tension cords.  
Clip the tension cord to the mounted loop.  
Clip the tension cord to the row bar.

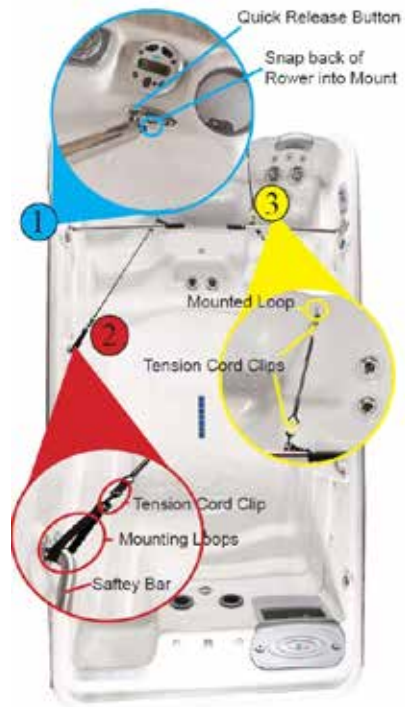

The tension cords are varying sizes to compensate for different levels of tension.

## Rowing

Sit in the rowing seat and grasp the rower handles, to begin your rowing exercise.



Double check the Rowers, making sure that each clip, cord and rower is mounted securely.



# UPPER BODY WORKOUTS

1

**Install Tension Cords**  
Choose a desired pair of the varying length tension cords.  
Clip the tension cords to the mounted loops.  
Attach handles to the tension cords.

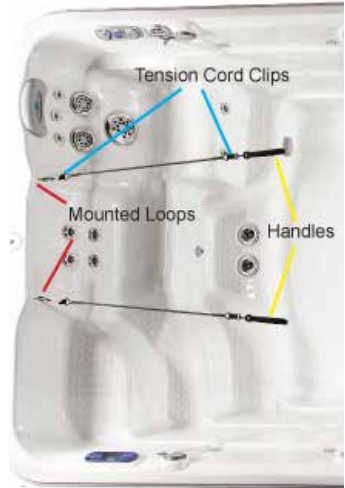

**Chest Press**  
Standing upright and facing away from the cords, Position your hands and elbows at your sides, chest

level. Keeping your elbows at chest level, push until your arms are outstretched in front of you.

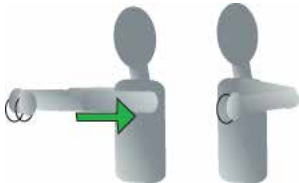

**Shoulder Pull**

Stand upright holding the cords in front of you with a little bit of tension. Start with arms and hands at chest level and outstretched in front of you. Pull arms to your sides, keeping your elbows at chest level.

**Back Pull**  
Stand upright holding the cords in front of you with a little bit of tension. Start with arms at chest height and outstretched in front of you. Bend your arms, and pull your elbows diagonally to your waist.



**Tricep Pull**

Sitting in the seat and facing away from the cords, position your elbows chest level, and hands eye level. Keeping your elbows parallel to your shoulders, pull until your arms is outstretched in front of you.

# TREADMILL WITH SUPER SWIM

- 1** Install Super Swim Pole  
Attach the two poles together by matching up the brass attachments and twisting until tightened.  
Place bottom of the pole into the attachment on the lip of the pool, above the rowing seat. Adjust nylon rope to desired length.

- 2** Install Waist Band  
Pull the stainless steel clip along the waist band to adjust belt's diameter.  
Strap waist belt attachment to your waist by buckling the smaller clip into the larger, angled clip.

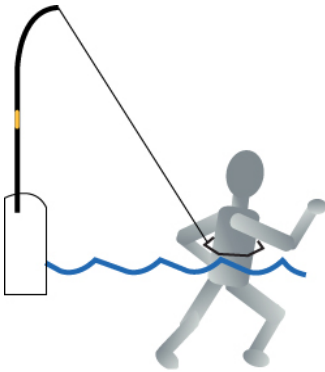

Treadmill  
Run in place, utilizing water resistance.

# ADVANCED SWIMMING WITH SUPER SWIM

- 2** Install Waist Band  
Strap waist belt attachment to your waist by clipping the smaller clip into the larger angled clip.

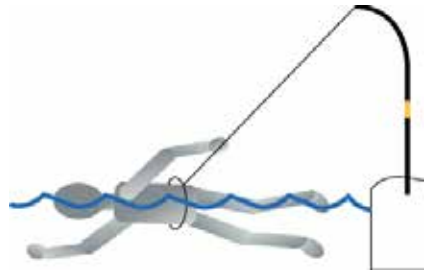

Swimming with Added Resistance  
Practice advanced swimming techniques and swim at a faster rate with the waist attachment.



For more information on the installation and use of the Super Swim, please refer to the DVD.



# MAINTAINING YOUR TIDALFIT

---

## DRAINING YOUR TIDALFIT

---

Your spa needs to be drained, cleaned, waxed and refilled about every six months. More frequent water changes may be necessary if bather load is heavy. A hose bib has been provided to assist you in draining your spa.

1) Turn off the power to your pool. If you fail to turn the power off, vital components could be damaged. Do not leave an empty pool exposed for long periods of time in hot, sunny weather.



2) Pull tab and then turn counter clockwise till cap is removed.



3) Connect the hose to the hose bib



4) Pull hose bib out to ensure opening of nozzle/drain plug.



5) Check the garden hose end to see if water is flowing. If water is not flowing, check the hose for kinks. Also check to see if valve is in the full open position.

**CAUTION: The chemical content and temperature of the water will cause damage to certain vegetation. We do not recommend that you drain your pool onto plants or lawns. If you choose to do this, please remove your pool cover and allow pool to cool for a minimum of 24 hours with the pool turned off.**

## PILLOW CARE

---

Remove and clean the pillows with soapy water and a soft cloth when needed. Use a vinyl conditioner once a month. Remove pillows when doing chemical shock treatment.

# MAINTAINING YOUR TIDALFIT

---

## JET CARE

---

We recommend that you clean your jets when you drain your pool. However, if you do need to clean your jets in between this can be accomplished with a full pool.

- 1) To remove the jet inserts turn the jet counterclockwise to the off position until it stops. Continue to turn the jet past the stop point to loosen it from the pool. The insert will now pull out.



- 2) Soak jet inserts in a mixture of 1 part vinegar to two parts warm water for 2-3 hours. Periodically rotate the spinner nozzle to break up residue in the jets.

- 4) Rinse the jet inserts under warm water.

- 5) To reinstall the jets insert jet into jet body and turn clockwise until fully seated then tug to make sure it is seated properly. You can then continue to turn clockwise until it stops.



**NOTE: A jet with stainless steel escutcheons can be slippery. You can use a soft cloth or jar-opening pad to assist in removing and installing the jet.**

# MAINTAINING YOUR TIDALFIT

---

## REMOVING, INSTALLING AND CLEANING FILTERS

---

These are the steps needed to successfully replace your filters. You should replace your disposable pool filters and clean your non-disposable filters every four months.

- 1) Turn off all power to your pool and remove the filter lid by lifting it out towards you.
- 2) Turn the filter counterclockwise and remove it from the filter well.
- 3) Dispose of the used filter.
- 4) To replace, set screen back into its place turn clockwise to fasten. DO NOT over-tighten.
- 5) Place the new filter into position and turn clockwise to fasten. DO NOT over-tighten.
- 6) Follow the directions 1) and 2) for the pleated filter cartridge. You then rinse the filter with a garden hose and soak the filter in a mixture of one pint of filter cleaner with 2.5 gallons of water for at least 12 hours. The filter must be completely submerged. You then follow the directions 4) and 5) to replace the filter.

**WARNING: Power to your pool must be turned off prior to removing your filters. The suction at the filter is extremely strong and can cause injury if there is no filter. NEVER run your pool without the filters properly installed. Injury to person and damage to the equipment can occur. Any damage to equipment due to this circumstance will not be covered under warranty.**

## WINTERIZING YOUR TIDALFIT

---

It is not recommended that you drain your pool completely during freezing conditions. We recommend that you leave your pool full of water with the power on to keep the tub from freezing. If you decide to drain your pool during freezing conditions, contact your dealer for help. Contact your dealer before refilling a drained pool in freezing temperature.

**WARNING: Damage to your pool caused by freezing is NOT covered under warranty. Please contact your local Artesian dealer to assist you in winterizing your pool.**

# MAINTAINING YOUR TIDALFIT

---

## REPLACING THE LIGHT BULB

---

- 1) Turn off the power at the main electrical service panel.
- 2) Remove front access panel.
- 3) Locate and remove the reflector by turning it counterclockwise until free from wall fitting.
- 4) Remove the bulb from the holder.
- 5) Replace with new bulb. Your dealer has these bulbs in stock.
- 6) Replace the reflector by screwing it clockwise back onto the wall fitting.
- 7) Replace the front panel.
- 8) Turn power on at the main electrical service panel.

**NOTE: The pool light bulb is not covered under warranty.**

## TIDALFIT CABINET CARE

---

Your pool comes standard with a KingWood, or faux wood, cabinet. This cabinet requires no maintenance. You may wish to clean the cabinet with mild soap and water from time to time. If you elected to purchase your TidalFit with a wood cabinet, this cabinet is stained and sealed with an oil based acrylic stain. The stain is formulated especially for pool cabinet and deck applications and is resistant to ultraviolet light damage caused by sun rays. It is also resistant to fungus and insect damage. Your dealer carries this type of stain for your convenience, so call your dealer when you're ready to re-stain your cabinet. You should re-stain your wood cabinet at least once a year, or more frequently depending on your environmental conditions.

- 1) Gently wash the cabinet with mild soap and water and allow to dry completely.
- 2) Moisten a rag with the stain you have purchased from your dealer.
- 3) Apply the stain on the entire cabinet surface, wiping off any excess stain as you are applying.
- 4) Allow stain to dry for a minimum of 24 hours before getting the cabinet wet.

# MAINTAINING YOUR TIDALFIT

---

## TIDALFIT CABINET CARE

---

NOTE: Do not apply any solid type finish such as shellac or varnish. After weathering, these types of finishes will crack and/or turn yellow. To refinish the wood, you will need to completely strip the finish before applying the new one. Use only the stain recommended by your dealer for refinishing your pool.

## CLEANING YOUR TIDALFIT INTERIOR

---

It is important to clean the interior of your pool every time it is drained to help preserve the sheen of your pool's surface. However, it is important that you do not use any abrasive cleaners or strong chemicals. Your authorized dealer will be able to supply you with the proper solution for your pool. After cleaning, make sure all residues are removed prior to filling the pool. This will help prevent sudsing and improper chemical balance.

## COVER CARE

---

Cleaning of your pool cover is an important part of routine maintenance. Dirt acts as an abrasive to the vinyl topcoat, and can also cause wear to folds, seams, and stitching. Mildew growing on damp, dirty vinyl will begin to actually root in the fabric, accelerating failure. Follow this simple routine for cleaning, prior to application of vinyl protectant:

- 1) Rinse with cool water using a garden hose.
- 2) Spray with a gentle, non-foaming cleaner and wipe clean. Never use laundry detergent, abrasives, alcohols, dish soaps or harsh cleaners. These can actually remove some of the topcoat and cause premature vinyl failure.
- 3) For stubborn dirt, use a non-abrasive sponge.
- 4) Rinse again thoroughly with water and allow to dry.
- 5) Repeat monthly, or as needed.

Your vinyl cover is affected by the UV in sunlight. Periodic treatment with a liquid protectant will extend the life of your pool cover. The wrong kind of protectant can be more harmful than no protectant at all. Keep any product away from your pool that is labeled "flammable," that contains any type of oil, or that leaves a waxy coating on your cover.

Never stand or sit on the cover and never drag it over abrasive surfaces. Lift cover only by the handles provided.

# MAINTAINING YOUR TIDALFIT

---

## CHEMICAL TREATMENT OF WATER

---

Water from your tap is fine for showers, bathing and drinking. However, in a contained recirculating system such as in a pool, water must be treated with chemicals. The main purpose of chemical treatment is to keep the water sanitary and to maintain a specific balance of the water. Proper balance ensures that the water will not cause irritation to the users or harm the spa's components. Chemical treatment does have its limitations. When water evaporates, chemical residues are left behind. As the levels of the residues combine with other types of residue, such as body oil and detergents, your water becomes increasingly difficult to maintain. Because of this residual effect, at some point it becomes easier and more cost-effective to drain, clean and refill your pool with new water. We recommend that the water be changed at least every six months. At this time you should also clean or replace your filters. If your pool has a frequent and/or heavy bather load, it may be necessary to drain and fill your pool more often. Refer to the section titled "Draining your TidalFit" for instructions (page 44).

**WARNING: Pool damage due to improper chemicals is not covered under warranty.**

**CAUTION:** The chemicals used to maintain the pH balance of the water and to sanitize the water can be dangerous. Always follow these basic guidelines when handling the chemicals:

1. Always read and follow the directions on the label, unless directed otherwise.
2. Never mix different chemicals.
3. Do not exceed the recommended amounts of chemicals—follow the directions on the label.
4. Keep all chemicals out of the reach of children and pets.
5. Keep containers closed tightly when not in use.
6. Never add water to the chemicals—always add the chemicals to the water as directed.
7. Always store chemicals in a cool, dry place.

**NOTE: When adding chemicals run all pumps for one cycle with cover off. Do this for each chemical added.**

# TIDALFIT WARRANTY

---

This section is a description of your warranty. Here you will find descriptions of what is covered under your Tidal Fit Spa warranty and what can void your warranty. **PLEASE READ THE WARRANTY THOROUGHLY.** Please take a moment to register your warranty. You can register on line at <http://www.tidalfit.com>, click on owner login or you mail in the warranty registration card attached to this manual. For warranty outside USA and Canada, please refer to your countries Artesian Distributor.

## **LIFETIME STRUCTURE WARRANTY**

TidalFit Spas carry a lifetime structure warranty. The structure is defined as the fiberglass vessel below the exposed material finish. The manufacturer warrants the spa against loss of water due to a defect in the spa structure. In the event of a defect in the material and/or workmanship, the spa structure will be repaired or replaced at the discretion of the manufacturer. **THIS WARRANTY IS GIVEN ONLY TO THE ORIGINAL OWNER, AND TERMINATES UPON TRANSFER OF OWNERSHIP. COMMERCIAL APPLICATIONS ARE EXCLUDED FROM THIS AND ALL WARRANTIES.**

If the spa structure is defective and must be replaced, it will be returned to the factory. The original, installed equipment (this includes the frame, skirt, and all equipment) will be reinstalled. If new equipment is desired, there will be additional charges to the customer. If the frame and/or skirt of the spa has been badly damaged, there will be additional charges to the spa owner for repairs or replacement. When a spa needs to be returned to the factory for repair, the cost of one way freight to the company will be at the spa owner's expense. The manufacturer will not pay for removal, installation, cranes, construction, de-construction, or any other cost associated with access, egress, or ingress, of the spa at the customer's home. The manufacturer reserves the right to an on-site inspection by its authorized representative. In the unlikely event a shell or spa must be replaced, all warranties (shell, surface, electrical and plumbing) date back to the original start date of the warranty. The warranty period starts either the day of delivery to the customer or eighteen (18) month from the date of manufacturing, whichever date comes first.

## **SEVEN-YEAR SURFACE WARRANTY**

The spa surface is described as the exposed acrylic material finish. The manufacturer warrants the spa surface to be free from defects in the material and workmanship, such as blistering, cracking, or de-laminating, this does not cover micro-crazing, under normal use and maintenance for a period of seven years from the original start date of the warranty. The warranty period starts either the day of delivery to the customer or eighteen (18) month from the date of manufacturing, whichever date comes first.

**THIS WARRANTY IS GIVEN ONLY TO THE ORIGINAL OWNER, AND TERMINATES UPON TRANSFER OF OWNERSHIP.**

# TIDALFIT WARRANTY

---

**COMMERCIAL APPLICATIONS ARE EXCLUDED FROM THIS AND ALL WARRANTIES.**

The spa must be set on a level solid surface that is sufficient to support the entire length and width of the spa. Standard building practices must be followed. Damage caused by failure to have a leveled and supported foundation under the spa is not covered under warranty. The manufacturer does not warrant problems associated with prolonged exposure to the sun and/or use of any sanitization or ozone system not approved by the manufacturer. Damage to the spa surface caused by leaving the spa uncovered and empty of water with direct sunlight exposure will terminate this warranty. Any alteration to any system, electrical, plumbing, or mechanical, or over use of chemicals, or any other problems caused by external source are not covered under warranty. Other exclusions may apply.

Normally problems associated with material and workmanship can and will be repaired. If the spa surface is repaired, the repair is limited to the affected area only, and there is no guarantee against discoloration of fading. The decision to repair will be made by the manufacturer and its field representative after a review of the facts, pictures, or any other data presented by the dealer or customer. In all cases, pictures of the affected area and foundation of the spa must be provided before any decisions to repair or replace can be made. In the unlikely event a shell or spa must be replaced, all warranties (shell, surface, electrical and plumbing) date back to the original date of installation. If it is determined that the surface is to be replaced, the same conditions and terms as outlined in the shell warranty will apply.

## **FIVE-YEAR ELECTRICAL WARRANTY**

(i.e., pumps, equipment packs, heaters, topside, etc.)

The MANUFACTURER warrants all electrical equipment to be free from defect in material and workmanship for five-years from the original start date of the warranty. The warranty period starts either the day of delivery to the customer or eighteen (18) month from the date of manufacturing, whichever date comes first. **THIS WARRANTY IS GIVEN ONLY TO THE ORIGINAL CONSUMER AND TERMINATES UPON TRANSFER OF OWNERSHIP. COMMERCIAL APPLICATIONS ARE EXCLUDED FROM THIS AND ALL WARRANTIES.**

The stereo, speakers, L.E.D. lighting, and Ozone are not included in this warranty but are covered under a separate warranty.



# TIDALFIT WARRANTY

---

Damage caused by acts of nature, poor water chemistry, and/or improper maintenance will not be covered under this warranty. Alterations or replacements of components installed in the spa that are not purchased and/or approved by the MANUFACTURER, including incorrect wiring, will terminate the complete spa warranty

## **FIVE YEAR PLUMBING WARRANTY**

The plumbing is described as all piping, jet bodies, valve bodies and air controls. The manufacturer warrants all plumbing for a period of five years from the original start date of the warranty. The warranty period starts either the day of delivery to the customer or eighteen (18) month from the date of manufacturing, whichever date comes first. **THIS WARRANTY IS GIVEN ONLY TO THE ORIGINAL OWNER, AND TERMINATES UPON TRANSFER OF OWNERSHIP. COMMERCIAL APPLICATIONS ARE EXCLUDED FROM THIS AND ALL WARRANTIES.**

Jet internals, valve handles, and other such items are regular maintenance items. They are covered for the item only; labor is not covered for these items. Damage caused by acts of nature, poor water chemistry, and/or improper maintenance will not be covered under this warranty.

## **TWO YEAR CABINET WARRANTY**

The spa cabinet is described as the outer material encasing the spa structure. The manufacturer warrants it to be free from defects in material and/or workmanship from the original start date of the warranty. The warranty period starts either the day of delivery to the customer or eighteen (18) month from the date of manufacturing, whichever date comes first.

**THIS WARRANTY IS GIVEN ONLY TO THE ORIGINAL OWNER, AND TERMINATES UPON TRANSFER OF OWNERSHIP. COMMERCIAL APPLICATIONS ARE EXCLUDED FROM THIS AND ALL WARRANTIES.**

This warranty does not cover normal darkening, staining, or aging. The spa cabinet requires care and maintenance by the consumer. Damage caused by acts of nature, poor water chemistry, and/or improper maintenance will not be covered under this warranty.

## **OTHER ITEMS NOT COVERED IN THIS WARRANTY**

Some items are not covered in this warranty. These items either have a different warranty, or are warranted through the manufacturer of that item.

# TIDALFIT WARRANTY

---

## **STEREO AND STEREO COMPONENTS**

The stereo and stereo components, including speakers, sub-woofer, stereo power supply, wire harness and remote control are covered for 30 days from the original start date of the warranty. The warranty period starts either the day of delivery to the customer or eighteen (18) month from the date of manufacturing, whichever date comes first. Please note: Warranty coverage for both parts and labor is covered for 30 days only. Parts, not labor, will be covered for one year from date of installation. This warranty does not cover damage to a stereo or stereo component from abuse, poor reception, or damage caused by putting a wet CD into the stereo. If a stereo is replaced under this warranty, the manufacturer reserves the right to replace the unit with another like unit, but not necessarily the same stereo manufacturer. No spa will be replaced for a failed stereo. The stereo does not affect the performance of the spa.

NOTE: For all operating instructions see the stereo manufacturer's owner's manual included with the spa.

## **OZONATOR**

The ozonator is covered for one year from the original start date of the warranty. The warranty period starts either the day of delivery to the customer or eighteen (18) month from the date of manufacturing, whichever date comes first.

## **SPA COVER**

The spa cover manufacturer warrants the spa cover skin for one year from the original start date of the warranty. The warranty period starts either the day of delivery to the customer or eighteen (18) month from the date of manufacturing, whichever date comes first. Do not return the spa cover to the manufacturer. This will delay the replacement or repair of the cover.

The spa manufacturer is not responsible for lost covers.

## **LIGHTING**

The lighting is guaranteed to work upon delivery. There is no warranty covering the lighting.

# TIDALFIT WARRANTY

---

## **PERFORMANCE**

In the event of any defect covered by this LIMITED warranty, a May Manufacturing LLC, authorized agent will correct such defect within the terms and conditions contained herein. There will be no charge for parts or labor within the above terms. However, travel charges that occur will not be covered under terms and conditions by the warranty. If it is determined by May Manufacturing LLC that the repair of the product is not feasible, a replacement spa equal to the value of the original purchase price will be provided. Cost for removal of the defective spa and delivery and installation of the replacement spa is the responsibility of the homeowner and will not under any circumstances be covered by May Manufacturing LLC.

## **LIMITATIONS**

This warranty is void if this Artesian Spa has been subjected to alteration, misuse, or repairs have been performed by anyone other than an authorized agent of May Manufacturing LLC. Misuse or abuse is defined as: use of the spa in a nonresidential application, water temperature outside the range of 32 degrees F to 110 degrees F, damage caused by clogged or dirty filter cartridges, damage to the spa from an absence of a hard cover, damage to components from improper pH, use of any type of acid, or from chemical imbalance. ACTS OF NATURE are not covered under this warranty.

Note: Warranty on 50Hz spas excludes labor.  
(Outside US and Canada)

## **DISCLAIMER**

May Manufacturing LLC, or its agent shall not be liable for any injury, cost or other damage, whether incidental or consequential, arising out of any defect covered by the LIMITED WARRANTY. The liability of May Manufacturing LLC under this LIMITED WARRANTY shall not exceed the original amount paid for the spa.

# TIDALFIT WARRANTY

---

## **LEGAL REMEDIES**

This LIMITED WARRANTY gives specific rights, and other rights that may apply and will vary from state to state.

## **WHAT IS NOT COVERED UNDER YOUR WARRANTY**

The following is a general overview of non-warranty items and work. This is not an all-inclusive list.

Diagnosis of Spa Problems  
Fuses  
Light Bulbs of Any Kind  
Removing a Spa from a Structure  
Pillows  
Filters  
Chemical Misuse / Damage  
Filter Lids  
Any Part not Purchased from Artesian Spas  
Jet Inserts  
Valve Handles  
Pump Seals  
Draining and filling the Spa  
Acts of Nature  
Travel Charges  
Cabinet Screws  
Incorrect Wiring  
Shipping Charges

***THIS WARRANTY IS GIVEN ONLY TO THE ORIGINAL OWNER, AND TERMINATES UPON TRANSFER OF OWNERSHIP. COMMERCIAL APPLICATIONS ARE EXCLUDED FROM THIS AND ALL WARRANTIES.***

Any alteration of the spa that has not been pre-authorized by the manufacturer will void all warranties. If the manufacturer approves an alteration, verify that this alteration is covered under warranty. Damage caused by moving a spa that is blocked in or that has been recessed, along with additional charges for labor, is not covered by this warranty

# INTERIOR SPA DIAGRAM

---



TidalFit Dual Swim Spa Configuration



TidalFit Hydrotherapy Spa Configuration

# INTERIOR SPA DIAGRAM

---



TidalFit Quad Swim Spa Configuration



TidalFit In-Ground Spa Configuration

# TIDALFIT PARTS LIST

<b>PART NUMBER</b>	<b>DESCRIPTION</b>
OP33-0666-08	SPA PACK MEL2SWIM
33-0617-08	SPA PACK EL2000
33-0612-08	SPA PACK MVS504SZ
OP24-0665-08	15" HEATER
OP24-0617-08HT	EL2000 HEATER
OP24-0614-08HT	MEL2SWIM HEATE
OP24-0216-08	MVS504SZ HEATER
33-0653-08	VL700S TOPSIDE
33-0654-08	ML700 TOPSIDE
11-0146-08	TOPSIDE OVERLAY
21-0064-81	VIPER PUMP
21-0054-81	SPECK PUMP
21-0048-81	4.8 HP 1-SPEED PUMP
21-0015-81	HI-FLO CIRCULATION PUMP
33-0257-16	AQUATIC AV STEREO
33-0001-17	BLUETOOTH STEREO
33-0090-98	POWER SUPPLY
33-0242-16	BLACK SPEAKER
33-0085-56	GRAY SPEAKER
33-0246-16	SPEAKER COVER
06-0012-12	BLUE FILTER
06-0055-12	PURPLE FILTER
OP96-0017-00P	NATURE 2
06-0050-48	FILTER CAP
25-0011-08	OZONE
26-0210-85	LOUNGE PILLOW
26-0250-85	FILTER LID
11-0211-77	DOME PILLOW INSERT
03-1702-48	OLD FAITHFUL SWIM JET
03-1700-52	BADU STREAM JET
03-1006-52	2" CLUSTER JET
03-1210-52	3" HELIX ROTO JET
03-1110-52	3" DIRECTIONAL JET
03-1411-52	5" MASSAGE JET
03-1413-52	5" DIRECTIONAL JET
03-1600-52	7" JUMBO JET

Place  
Stamp  
Here

---

---

---

Please do not send products or  
other correspondence to the  
address below.

ARTESIAN SPAS  
Attn: Customer Care Department  
4720 N. Lamb Blvd.  
Las Vegas, NV 89115



## SPA & WARRANTY REGISTRATION

Activate Product Warranty & Download Owner's Manuals

Please activate your warranty and register your spa by mailing in this reply card, or go online at [www.TidalFit.com](http://www.TidalFit.com) and click on owner login.

*(Serial # is required below and can be located on the bottom kick plate of the spa, or can be found within the cabinet next to the equipment on a white placard attached to the frame.)*

Name \_\_\_\_\_

Address \_\_\_\_\_

City \_\_\_\_\_ State \_\_\_\_\_ Zip \_\_\_\_\_

Phone Number \_\_\_\_\_

Date of Installation \_\_\_\_\_ Spa Serial Number (required) \_\_\_\_\_

Spa Model \_\_\_\_\_

Your Dealers Name and Location \_\_\_\_\_

### Optional Questions:

What other spa brands did you consider buying? \_\_\_\_\_

How many people are in your household? \_\_\_\_\_

What is your age bracket?    25-30     31-40     41-50     51-60     61-70     71+

What is your reason for purchasing a spa?  Health Benefits  Stress  Relief  Relaxation

Other: \_\_\_\_\_





4720 N. Lamb Blvd.  
Las Vegas, Nevada 89115  
[www.TidalFit.com](http://www.TidalFit.com)